

applelec<sup>TM</sup>  
signpik



2020  
LETTERING COLLECTION

## WE INSPIRE TO CREATE AMAZING PLACES



Applelec SignPik is a curated range of products derived from over 20 years of industry experience.

Through Applelec SignPik we inspire to create amazing places, with an innovative range of finishes and manufacturing techniques that will not fail to impress.

For me, Applelec SignPik is a range of products that enables creativity; its style and quality is distinguished and its selection is simple and customer focused.

We are excited to support our clients with this exceptional range and we retain the Applelec promise; to never sell directly to end users.

A handwritten signature in black ink, appearing to read 'Ian Drinkwater'. The signature is fluid and cursive, with a long horizontal stroke at the beginning.

**Ian Drinkwater**, Managing Director

## Introducing Applelec SignPik



06 SignPik  
Illuminated Finishes



30 SignPik  
Neon Finishes



54 SignPik  
Metal Finishes



64 SignPik  
Colour Finishes

# Unleash your individuality

Applelec SignPik allows your style to shine. This extensive range of products has been designed to complement your vision.



## Convenience without compromise

Applelec SignPik work only with specialist distributors. These professionals support you to achieve your aspiration in line with your budget.



# Discover innovation

Applelec SignPik is distinguished by exceptional finishes and precision manufacturing to deliver a striking and unique impact.



# Applelec assurance

Applelec SignPik combines over twenty years of industry expertise to form the range. It is fully supported with the Applelec Quality Guarantee and a 1 year UK Warranty.

---

# Illuminated Finishes

The luminosity of Applelec SignPik illuminated signs is flawless. These energy efficient, LED letters offer the versatility of either face or halo illumination in a range of colour and metal finishes.







---

# Face Illuminated

The striking and elegant effect of Applelec SignPik face illuminated letters is unprecedented. The wide choice of both LED colour options and metal returns provides a customised finish, which is tailored to suit your design.

The consistency of light is controlled with a detailed routed internal structure to the letter's acrylic faces, allowing wider distribution of light in tight crevices. A choice of 3000K warm white or 5000K cool white light is available on all products.





A striking face illuminated letter.



The dark obsidian tone creates contrast against the illuminated face.



Illumination is available in two colour temperatures – 3000K warm white and 5000K cool white.

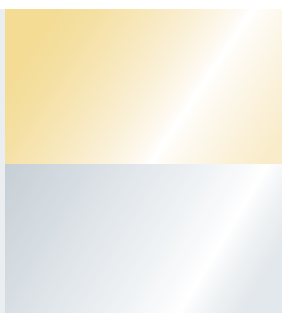

Obsidian Face Illuminated - Style 1

Pik Your Style	
Styles available Range Code: ILU-FCL-OBS-POL-BLO	
<b>Style 1</b>	<b>Style 4</b>
Style 2*	<b>STYLE 5</b>
Style 3*	<b>Style 6</b>
Range Code: ILU-FCL-OBS-POL-SER	
<b>Style 7</b>	<b>Style 10</b>
Style 8	<b>STYLE 11</b>
<b>Style 9</b>	<b>Style 12</b>

Pik Your Size						
Depth (mm)	Height (mm)					
	100	150	200	250	300	400
30	61.92	92.88	123.83	154.79	178.75	238.34
45	65.48	98.21	130.95	157.52	189.03	252.03
60	69.03	103.55	138.07	166.08	199.30	265.73
*Style not available in 100mm high						
30	63.82	95.72	127.63	153.53	184.23	245.64
45	67.37	101.06	134.75	162.09	194.51	259.34
60	70.93	106.40	141.86	170.65	204.78	273.04
Manufacturer's recommended prices exclude VAT						

Pik Your Options			
Applications		Fixings	
Internal	External	Tape	Stud
✓	-	-	✓
✓	-	-	✓
✓	-	-	✓
✓	-	-	✓

Note: Pricing is per letter based on the tallest letter in the sentence or word. Above prices are manufacturer's recommended retail prices excluding VAT and include a one year guarantee.

Estimated lead time is 3 weeks from order.

**Pricing includes**

- Fitting Template
- Choice of fixings
- Applelec quality inspection

**See your specialist distributor for:**

- Bespoke options
- Installation advice
- Delivery options
- A full quotation



# Polished Rose Gold

010 | Illuminated Finishes: Face



Polished Rose Gold Face Illuminated - Style 1

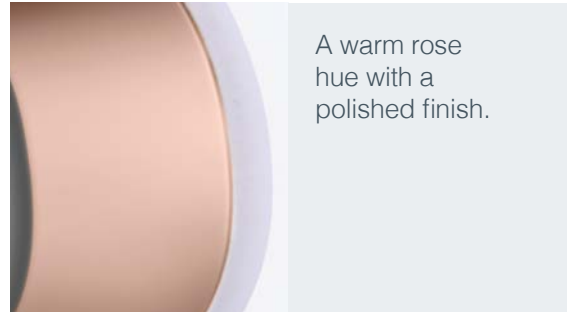

A warm rose hue with a polished finish.

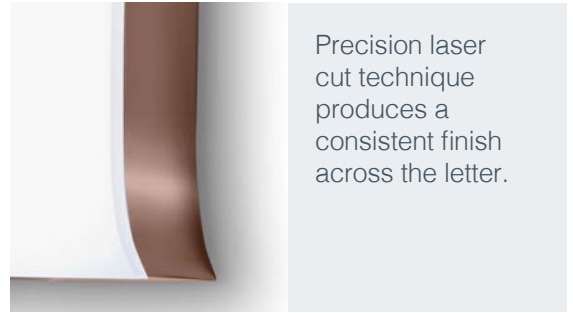

Precision laser cut technique produces a consistent finish across the letter.



Illumination is available in two colour temperatures – 3000K warm white and 5000K cool white.

Pik Your Style	
Styles available Range Code: ILU-FCL-RSG-POL-BLO	
<b>Style 1</b>	<b>Style 4</b>
Style 2*	<b>STYLE 5</b>
Style 3*	<b>Style 6</b>
Range Code: ILU-FCL-RSG-POL-SER	
<b>Style 7</b>	<b>Style 10</b>
Style 8	<b>STYLE 11</b>
<b>Style 9</b>	<b>Style 12</b>

Pik Your Size						
Depth (mm)	Height (mm)					
	100	150	200	250	300	400
30	61.92	92.88	123.83	154.79	178.75	238.34
45	65.48	98.21	130.95	157.52	189.03	252.03
60	69.03	103.55	138.07	166.08	199.30	265.73
*Style not available in 100mm high						
30	63.82	95.72	127.63	153.53	184.23	245.64
45	67.37	101.06	134.75	162.09	194.51	259.34
60	70.93	106.40	141.86	170.65	204.78	273.04

Manufacturer's recommended prices exclude VAT

Pik Your Options			
Applications		Fixings	
Internal	External	Tape	Stud
✓	-	-	✓
✓	-	-	✓
✓	-	-	✓
✓	-	-	✓
✓	-	-	✓

Note: Pricing is per letter based on the tallest letter in the sentence or word.  
Above prices are manufacturer's recommended retail prices excluding VAT and include a one year guarantee.

Estimated lead time is 3 weeks from order.

#### Pricing includes

- Fitting Template
- Choice of fixings
- Applelec quality inspection

#### See your specialist distributor for:

- Bespoke options
- Installation advice
- Delivery options
- A full quotation



# Brushed Rose Gold

A warm rose hue with a brushed finish.



Precision laser cut technique produces a consistent finish across the letter.



Illumination is available in two colour temperatures – 3000K warm white and 5000K cool white.

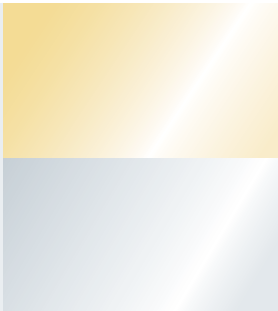

Brushed Rose Gold Face Illuminated - Style 1

Pik Your Style	
Styles available Range Code: ILU-FCL-RSG-BSH-BLO	
<b>Style 1</b>	<b>Style 4</b>
Style 2*	<b>STYLE 5</b>
Style 3*	<b>Style 6</b>
Range Code: ILU-FCL-RSG-BSH-SER	
<b>Style 7</b>	<b>Style 10</b>
Style 8	<b>STYLE 11</b>
<b>Style 9</b>	<b>Style 12</b>

Pik Your Size						
Depth (mm)	Height (mm)					
	100	150	200	250	300	400
30	60.26	90.39	120.51	150.64	173.96	231.95
45	63.82	95.72	127.63	153.53	184.23	245.64
60	67.37	101.06	134.75	162.09	194.51	259.34

\*Style not available in 100mm high

30	61.92	92.88	123.83	154.79	178.75	238.34
45	65.48	98.21	130.95	157.52	189.03	252.03
60	69.03	103.55	138.07	166.08	199.30	265.73

Manufacturer's recommended prices exclude VAT

Pik Your Options			
Applications		Fixings	
Internal	External	Tape	Stud
✓	-	-	✓
✓	-	-	✓
✓	-	-	✓
✓	-	-	✓

Note: Pricing is per letter based on the tallest letter in the sentence or word. Above prices are manufacturer's recommended retail prices excluding VAT and include a one year guarantee.

Estimated lead time is 3 weeks from order.

#### Pricing includes

- Fitting Template
- Choice of fixings
- Applelec quality inspection

#### See your specialist distributor for:

- Bespoke options
- Installation advice
- Delivery options
- A full quotation



# Copper Effect Polished



Copper Effect Polished Face Illuminated - Style 1

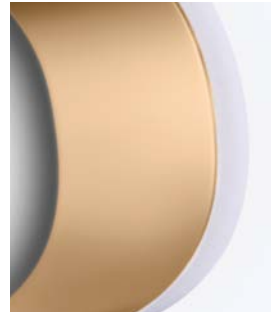

A beautifully nostalgic polished finish.



Precision laser cut technique produces a consistent finish across the letter.



Illumination is available in two colour temperatures – 3000K warm white and 5000K cool white.

012 | Illuminated Finishes: Face

Pick Your Style	
Styles available Range Code: ILU-FCL-COP-POL-BLO	
<b>Style 1</b>	<b>Style 4</b>
Style 2*	<b>STYLE 5</b>
Style 3*	<b>Style 6</b>
Range Code: ILU-FCL-COP-POL-SER	
<b>Style 7</b>	<b>Style 10</b>
Style 8	<b>STYLE 11</b>
<b>Style 9</b>	<b>Style 12</b>

Pick Your Size						
Depth (mm)	Height (mm)					
	100	150	200	250	300	400
30	61.92	92.88	123.83	154.79	178.75	238.34
45	65.48	98.21	130.95	157.52	189.03	252.03
60	69.03	103.55	138.07	166.08	199.30	265.73
*Style not available in 100mm high						
30	63.82	95.72	127.63	153.53	184.23	245.64
45	67.37	101.06	134.75	162.09	194.51	259.34
60	70.93	106.40	141.86	170.65	204.78	273.04

Manufacturer's recommended prices exclude VAT

Pick Your Options			
Applications		Fixings	
Internal	External	Tape	Stud
✓	-	-	✓
✓	-	-	✓
✓	-	-	✓
✓	-	-	✓
✓	-	-	✓

Note: Pricing is per letter based on the tallest letter in the sentence or word. Above prices are manufacturer's recommended retail prices excluding VAT and include a one year guarantee.

Estimated lead time is 3 weeks from order.

**Pricing includes**

- Fitting Template
- Choice of fixings
- Applelec quality inspection

**See your specialist distributor for:**

- Bespoke options
- Installation advice
- Delivery options
- A full quotation



# Bronze Effect Brushed

The bronze finish gives a feeling of understated heritage.



Precision laser cut technique produces a consistent finish across the letter.



Illumination is available in two colour temperatures – 3000K warm white and 5000K cool white.



Bronze Effect Brushed Face Illuminated - Style 1

Pik Your Style	
Styles available Range Code: ILU-FCL-BNZ-BSH-BLO	
<b>Style 1</b>	<b>Style 4</b>
Style 2*	<b>STYLE 5</b>
Style 3*	<b>Style 6</b>
Range Code: ILU-FCL-BNZ-BSH-SER	
<b>Style 7</b>	<b>Style 10</b>
Style 8	<b>STYLE 11</b>
<b>Style 9</b>	<b>Style 12</b>

Pik Your Size						
Depth (mm)	Height (mm)					
	100	150	200	250	300	400
30	60.26	90.39	120.51	150.64	173.96	231.95
45	63.82	95.72	127.63	153.53	184.23	245.64
60	67.37	101.06	134.75	162.09	194.51	259.34

\*Style not available in 100mm high

30	61.92	92.88	123.83	154.79	178.75	238.34
45	65.48	98.21	130.95	157.52	189.03	252.03
60	69.03	103.55	138.07	166.08	199.30	265.73

Manufacturer's recommended prices exclude VAT

Pik Your Options			
Applications		Fixings	
Internal	External	Tape	Stud
✓	-	-	✓
✓	-	-	✓
✓	-	-	✓
✓	-	-	✓

Note: Pricing is per letter based on the tallest letter in the sentence or word. Above prices are manufacturer's recommended retail prices excluding VAT and include a one year guarantee.

Estimated lead time is 3 weeks from order.

#### Pricing includes

- Fitting Template
- Choice of fixings
- Applelec quality inspection

#### See your specialist distributor for:

- Bespoke options
- Installation advice
- Delivery options
- A full quotation



# Polished Stainless Steel



Polished Stainless Steel Face Illuminated - Style 1



A smooth & bright polished stainless steel finish.



Precision laser cut technique produces a consistent finish across the letter.



Illumination is available in two colour temperatures – 3000K warm white and 5000K cool white.

014 | Illuminated Finishes: Face

Pik Your Style	
Styles available Range Code: ILU-FCL-SLS-POL-BLO	
<b>Style 1</b>	<b>Style 4</b>
Style 2*	<b>STYLE 5</b>
Style 3*	<b>Style 6</b>
Range Code: ILU-FCL-SLS-POL-SER	
<b>Style 7</b>	<b>Style 10</b>
Style 8	<b>STYLE 11</b>
<b>Style 9</b>	<b>Style 12</b>

Pik Your Size						
Depth (mm)	Height (mm)					
	100	150	200	250	300	400
30	51.24	76.86	102.48	128.10	153.73	197.24
45	54.80	82.20	109.60	137.00	158.21	210.94
60	58.36	87.54	116.72	145.90	168.48	224.64
*Style not available in 100mm high						
30	53.14	79.71	106.28	132.85	153.41	204.55
45	56.70	85.05	113.40	141.75	163.69	218.25
60	60.26	90.39	120.51	150.64	173.96	231.95

Manufacturer's recommended prices exclude VAT

Pik Your Options			
Applications		Fixings	
Internal	External	Tape	Stud
✓	-	-	✓
✓	-	-	✓
✓	-	-	✓
✓	-	-	✓
✓	-	-	✓
✓	-	-	✓

Note: Pricing is per letter based on the tallest letter in the sentence or word.  
Above prices are manufacturer's recommended retail prices excluding VAT and include a one year guarantee.

Estimated lead time is 3 weeks from order.

**Pricing includes**  
Fitting Template  
Choice of fixings  
Applelec quality inspection

**See your specialist distributor for:**  
Bespoke options  
Installation advice  
Delivery options  
A full quotation



# Brushed Stainless Steel

A textured brushed stainless steel finish.



Precision laser cut technique produces a consistent finish across the letter.



Illumination is available in two colour temperatures – 3000K warm white and 5000K cool white.

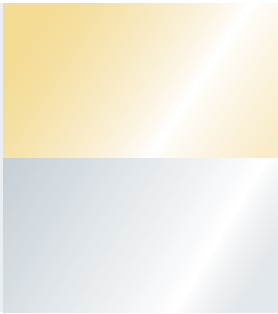

Brushed Stainless Steel Face Illuminated - Style 1

Pik Your Style	
Styles available Range Code: ILU-FCL-SLS-BSH-BLO	
<b>Style 1</b>	<b>Style 4</b>
Style 2*	<b>STYLE 5</b>
Style 3*	<b>Style 6</b>
Range Code: ILU-FCL-SLS-BSH-SER	
<b>Style 7</b>	<b>Style 10</b>
Style 8	<b>STYLE 11</b>
<b>Style 9</b>	<b>Style 12</b>

Pik Your Size						
Depth (mm)	Height (mm)					
	100	150	200	250	300	400
30	49.58	74.37	99.16	123.95	148.74	190.85
45	53.14	79.71	106.28	132.85	153.41	204.55
60	56.70	85.05	113.40	141.75	163.69	218.25
*Style not available in 100mm high						
30	51.24	76.86	102.48	128.10	153.73	197.24
45	54.80	82.20	109.60	137.00	158.21	210.94
60	58.36	87.54	116.72	145.90	168.48	224.64

Manufacturer's recommended prices exclude VAT

Pik Your Options			
Applications		Fixings	
Internal	External	Tape	Stud
✓	-	-	✓
✓	-	-	✓
✓	-	-	✓
✓	-	-	✓

Note: Pricing is per letter based on the tallest letter in the sentence or word. Above prices are manufacturer's recommended retail prices excluding VAT and include a one year guarantee.

Estimated lead time is 3 weeks from order.

#### Pricing includes

- Fitting Template
- Choice of fixings
- Applelec quality inspection

#### See your specialist distributor for:

- Bespoke options
- Installation advice
- Delivery options
- A full quotation





# Gold Effect Polished



Gold Effect Polished Face Illuminated - Style 1



A smooth & bright gold polished finish.



Precision laser cut technique produces a consistent finish across the letter.



Illumination is available in two colour temperatures – 3000K warm white and 5000K cool white.

016 | Illuminated Finishes: Face

Pik Your Style	
Styles available Range Code: ILU-FCL-GLD-POL-BLO	
<b>Style 1</b>	<b>Style 4</b>
Style 2*	<b>STYLE 5</b>
Style 3*	<b>Style 6</b>
Range Code: ILU-FCL-GLD-POL-SER	
<b>Style 7</b>	<b>Style 10</b>
Style 8	<b>STYLE 11</b>
<b>Style 9</b>	<b>Style 12</b>

Pik Your Size						
Depth (mm)	Height (mm)					
	100	150	200	250	300	400
30	61.92	92.88	123.83	154.79	178.75	238.34
45	65.48	98.21	130.95	157.52	189.03	252.03
60	69.03	103.55	138.07	166.08	199.30	265.73
*Style not available in 100mm high						
30	63.82	95.72	127.63	153.53	184.23	245.64
45	67.37	101.06	134.75	162.09	194.51	259.34
60	70.93	106.40	141.86	170.65	204.78	273.04
Manufacturer's recommended prices exclude VAT						

Pik Your Options			
Applications		Fixings	
Internal	External	Tape	Stud
✓	-	-	✓
✓	-	-	✓
✓	-	-	✓
✓	-	-	✓
✓	-	-	✓
✓	-	-	✓

Note: Pricing is per letter based on the tallest letter in the sentence or word.  
Above prices are manufacturer's recommended retail prices excluding VAT and include a one year guarantee.

Estimated lead time is 3 weeks from order.

**Pricing includes**  
Fitting Template  
Choice of fixings  
Applelec quality inspection

**See your specialist distributor for:**  
Bespoke options  
Installation advice  
Delivery options  
A full quotation



# Gold Effect Brushed

A textured brushed gold finish.



Precision laser cut technique produces a consistent finish across the letter.



Illumination is available in two colour temperatures – 3000K warm white and 5000K cool white.

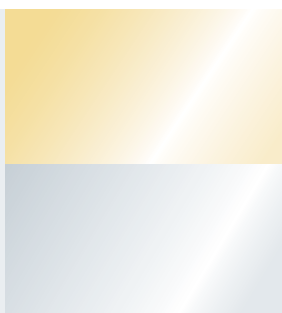

Gold Effect Brushed Face Illuminated - Style 1

Pik Your Style	
Styles available Range Code: ILU-FCL-GLD-BSH-BLO	
<b>Style 1</b>	<b>Style 4</b>
Style 2*	<b>STYLE 5</b>
Style 3*	<b>Style 6</b>
Range Code: ILU-FCL-GLD-BSH-SER	
<b>Style 7</b>	<b>Style 10</b>
Style 8	<b>STYLE 11</b>
<b>Style 9</b>	<b>Style 12</b>

Pik Your Size						
Depth (mm)	Height (mm)					
	100	150	200	250	300	400
30	60.26	90.39	120.51	150.64	173.96	231.95
45	63.82	95.72	127.63	153.53	184.23	245.64
60	67.37	101.06	134.75	162.09	194.51	259.34
*Style not available in 100mm high						
30	61.92	92.88	123.83	154.79	178.75	238.34
45	65.48	98.21	130.95	157.52	189.03	252.03
60	69.03	103.55	138.07	166.08	199.30	265.73
Manufacturer's recommended prices exclude VAT						

Pik Your Options			
Applications		Fixings	
Internal	External	Tape	Stud
✓	-	-	✓
✓	-	-	✓
✓	-	-	✓
✓	-	-	✓

Note: Pricing is per letter based on the tallest letter in the sentence or word. Above prices are manufacturer's recommended retail prices excluding VAT and include a one year guarantee.

Estimated lead time is 3 weeks from order.

#### Pricing includes

- Fitting Template
- Choice of fixings
- Applelec quality inspection

#### See your specialist distributor for:

- Bespoke options
- Installation advice
- Delivery options
- A full quotation



# Painted face illuminated



Painted Face Illuminated - Style 1

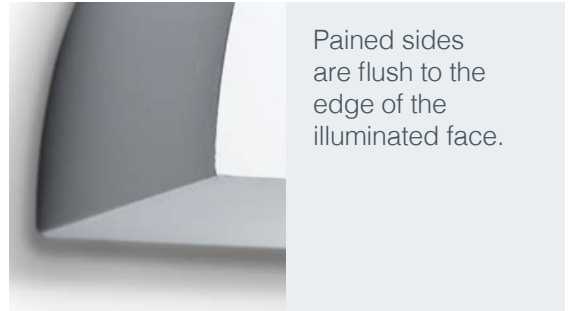

Painted sides are flush to the edge of the illuminated face.

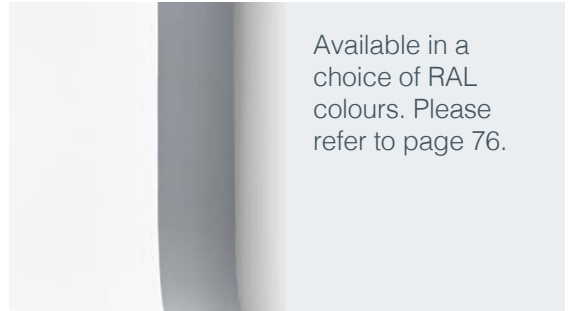

Available in a choice of RAL colours. Please refer to page 76.



Illumination is available in two colour temperatures – 3000K warm white and 5000K cool white.

Pik Your Style	
Styles available Range Code: ILU-FCL-ACR-PNT-BLO	
<b>Style 1</b>	<b>Style 4</b>
Style 2*	<b>STYLE 5**</b>
Style 3*	<b>Style 6**</b>
Range Code: ILU-FCL-ACR-PNT-SER	
<b>Style 7</b>	<b>Style 10</b>
Style 8**	<b>STYLE 11</b>
<b>Style 9</b>	<b>Style 12</b>

Pik Your Size						
Depth (mm)	Height (mm)					
	100	150	200	250	300	400
30	61.16	91.75	122.33	152.91	176.68	235.58
45	64.78	97.17	129.55	155.93	187.12	249.49
60	68.39	102.58	136.78	164.63	197.55	263.40

\*Style not available in 100mm or 150mm high  
\*\*Style not available in 100mm high

30	62.85	94.28	125.70	157.13	181.55	242.07
45	66.46	99.69	132.93	159.99	191.99	255.98
60	70.07	105.11	140.15	168.68	202.42	269.89

Manufacturer's recommended prices exclude VAT

Pik Your Options			
Applications		Fixings	
Internal	External	Tape	Stud
✓	-	-	✓
✓	-	-	✓
✓	-	-	✓
✓	-	-	✓
✓	-	-	✓

Note: Pricing is per letter based on the tallest letter in the sentence or word.  
Above prices are manufacturer's recommended retail prices excluding VAT and include a one year guarantee.

Estimated lead time is 3 weeks from order.

**Pricing includes**  
Fitting Template  
Choice of fixings  
Applelec quality inspection

**See your specialist distributor for:**  
Bespoke options  
Installation advice  
Delivery options  
A full quotation

---

# Halo Illumination

The elegance of halo illumination enhances the appearance of lettering complementing any design with refinement and sophistication. Applelec SignPik halo illumination diffuses the light produced by the LEDs through an acrylic base to produce a beautiful consistent glow on all surfaces without the LEDs being

visible. The discreet edge illumination allows for a smooth, uniform glow of light around the whole perimeter of the lettering. The construction comprises of a closed acrylic base excluding any shadowing, and allowing the letter to be mounted flush to the surface.

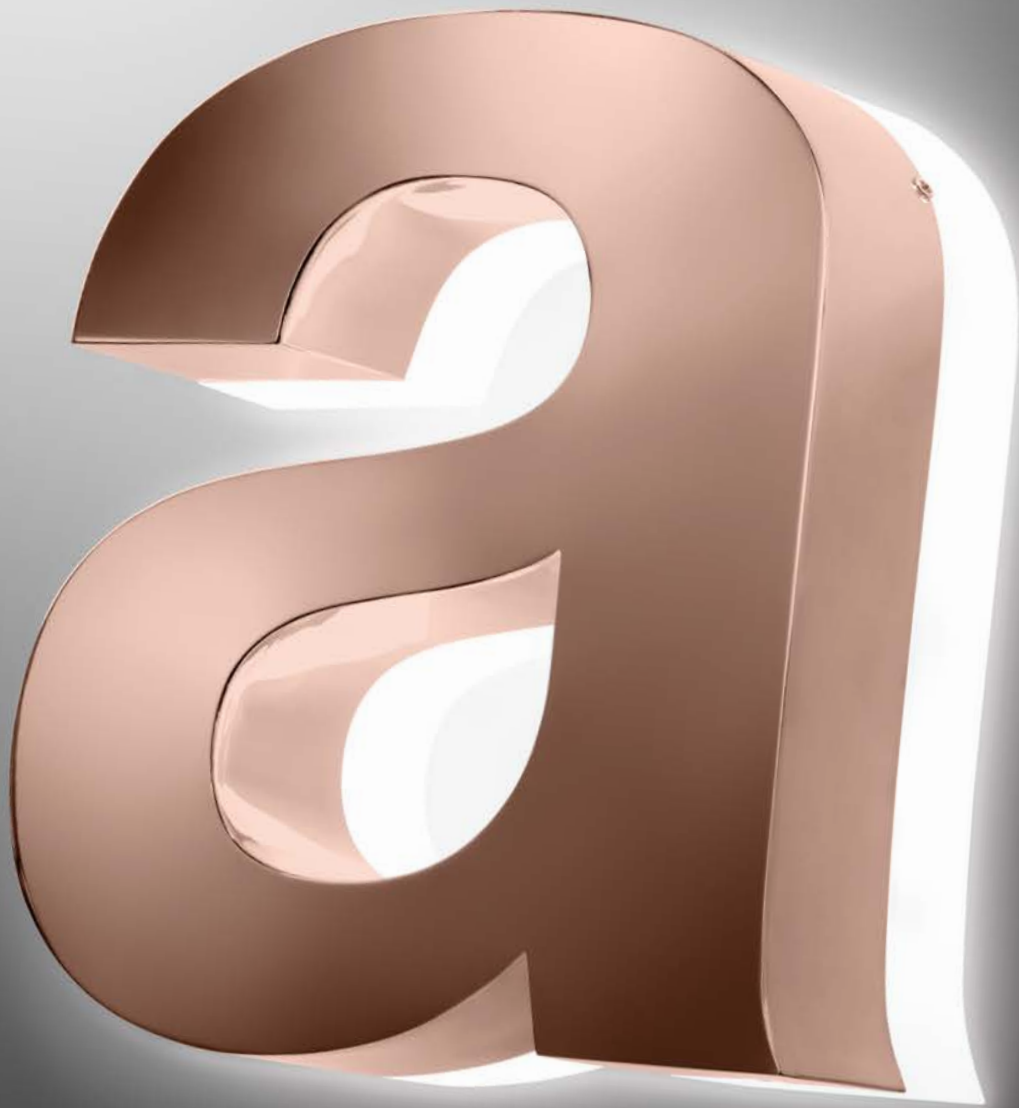



# Polished Rose Gold

020 | Illuminated Finishes: Halo



Polished Rose Gold Halo Illuminated - Style 1

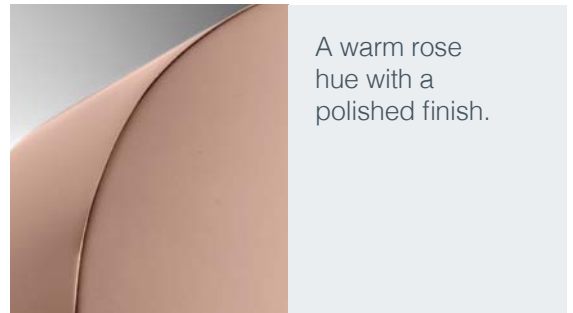

A warm rose hue with a polished finish.



The letter surface is enhanced by the halo effect.



Illumination is available in two colour temperatures – 3000K warm white and 5000K cool white.

Pik Your Style	
Styles available Range Code: ILU-IHL-RSG-POL-BLO	
<b>Style 1</b>	<b>Style 4</b>
Style 2*	<b>STYLE 5</b>
Style 3*	<b>Style 6</b>
Range Code: ILU-IHL-RSG-POL-SER	
<b>Style 7</b>	<b>Style 10</b>
Style 8	<b>STYLE 11</b>
<b>Style 9</b>	<b>Style 12</b>

Pik Your Size						
Depth (mm)	Height (mm)					
	100	150	200	250	300	400
30	76.15	114.23	152.30	183.20	219.85	293.13
45	79.71	119.56	153.41	191.77	230.12	294.81
60	83.27	124.90	160.26	200.33	240.39	307.97
*Style not available in 50mm high						
30	79.71	119.56	153.41	191.77	230.12	294.81
45	83.27	124.90	160.26	200.33	240.39	307.97
60	86.83	130.24	167.11	208.89	250.67	321.13
Manufacturer's recommended prices exclude VAT						

Pik Your Options			
Applications		Fixings	
Internal	External	Tape	Stud
✓	-	-	✓
✓	-	-	✓
✓	-	-	✓
✓	-	-	✓
✓	-	-	✓

Note: The depth of the product includes the metal and illuminated acrylic. The illuminated section is a third of the depth of the finished letter. Pricing is per letter based on the tallest letter in the sentence or word. Above prices are manufacturer's recommended retail prices excluding VAT and include a one year guarantee.

Estimated lead time is 3 weeks from order.

#### Pricing includes

- Fitting Template
- Choice of fixings
- Applelec quality inspection

#### See your specialist distributor for:

- Bespoke options
- Installation advice
- Delivery options
- A full quotation



# Brushed Rose Gold

A warm rose hue with a brushed finish.



The letter surface is enhanced by the halo effect.



Illumination is available in two colour temperatures – 3000K warm white and 5000K cool white.

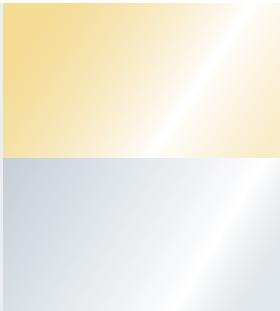

Brushed Rose Gold Halo Illuminated - Style 1

Pik Your Style	
Styles available Range Code: ILU-IHL-RSG-BSH-BLO	
<b>Style 1</b>	<b>Style 4</b>
Style 2*	<b>STYLE 5</b>
Style 3*	<b>Style 6</b>
Range Code: ILU-IHL-RSG-BSH-SER	
<b>Style 7</b>	<b>Style 10</b>
Style 8	<b>STYLE 11</b>
<b>Style 9</b>	<b>Style 12</b>

Pik Your Size						
Depth (mm)	Height (mm)					
	100	150	200	250	300	400
30	74.25	111.38	148.51	178.64	214.37	285.82
45	77.81	116.72	149.76	187.20	224.64	287.79
60	81.37	122.06	156.61	195.76	234.91	300.95

\*Style not available in 50mm high

30	77.81	116.72	149.76	187.20	224.64	287.79
45	81.37	122.06	156.61	195.76	234.91	300.95
60	84.93	127.39	163.46	204.32	245.19	314.11

Manufacturer's recommended prices exclude VAT

Pik Your Options			
Applications		Fixings	
Internal	External	Tape	Stud
✓	-	-	✓
✓	-	-	✓
✓	-	-	✓
✓	-	-	✓

Note: The depth of the product includes the metal and illuminated acrylic. The illuminated section is a third of the depth of the finished letter. Pricing is per letter based on the tallest letter in the sentence or word. Above prices are manufacturer's recommended retail prices excluding VAT and include a one year guarantee.

Estimated lead time is 3 weeks from order.

#### Pricing includes

- Fitting Template
- Choice of fixings
- Applelec quality inspection

#### See your specialist distributor for:

- Bespoke options
- Installation advice
- Delivery options
- A full quotation





# Copper Effect Polished



Copper Effect Polished Halo Illuminated - Style 1

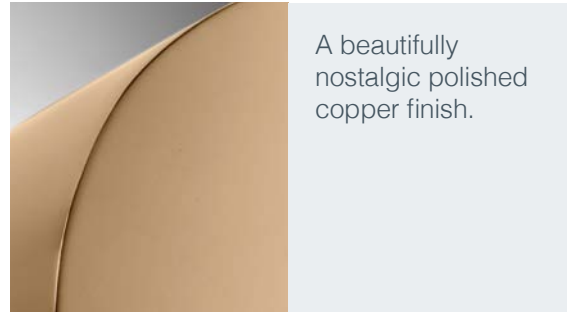

A beautifully nostalgic polished copper finish.



The letter surface is enhanced by the halo effect.



Illumination is available in two colour temperatures – 3000K warm white and 5000K cool white.

### Pik Your Style

Styles available  
Range Code: ILU-IHL-COP-POL-BLO

**Style 1**      **Style 4**

**Style 2\***    **Style 5**

**Style 3\***    **Style 6**

Range Code: ILU-IHL-COP-POL-SER

**Style 7**      **Style 10**

**Style 8**      **Style 11**

**Style 9**      **Style 12**

### Pik Your Size

Depth (mm)	Height (mm)					
	100	150	200	250	300	400
30	76.15	114.23	152.30	183.20	219.85	293.13
45	79.71	119.56	153.41	191.77	230.12	294.81
60	83.27	124.90	160.26	200.33	240.39	307.97

\*Style not available in 50mm high

30	79.71	119.56	153.41	191.77	230.12	294.81
45	83.27	124.90	160.26	200.33	240.39	307.97
60	86.83	130.24	167.11	208.89	250.67	321.13

Manufacturer's recommended prices exclude VAT

### Pik Your Options

Applications		Fixings	
Internal	External	Tape	Stud
✓	-	-	✓
✓	-	-	✓
✓	-	-	✓
✓	-	-	✓
✓	-	-	✓
✓	-	-	✓

Note: The depth of the product includes the metal and illuminated acrylic. The illuminated section is a third of the depth of the finished letter. Pricing is per letter based on the tallest letter in the sentence or word. Above prices are manufacturer's recommended retail prices excluding VAT and include a one year guarantee.

Estimated lead time is 3 weeks from order.

#### Pricing includes

- Fitting Template
- Choice of fixings
- Applelec quality inspection

#### See your specialist distributor for:

- Bespoke options
- Installation advice
- Delivery options
- A full quotation





# Bronze Effect Brushed

The bronze finish gives a feeling of understated heritage.



The letter surface is enhanced by the halo effect.



Illumination is available in two colour temperatures – 3000K warm white and 5000K cool white.

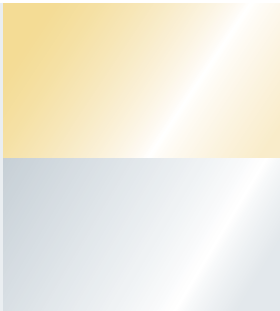

Bronze Effect Brushed Halo Illuminated - Style 1

Pik Your Style	
Styles available Range Code: ILU-IHL-BNZ-BSH-BLO	
<b>Style 1</b>	<b>Style 4</b>
Style 2*	<b>STYLE 5</b>
Style 3*	<b>Style 6</b>
Range Code: ILU-IHL-BNZ-BSH-SER	
<b>Style 7</b>	<b>Style 10</b>
Style 8	<b>STYLE 11</b>
<b>Style 9</b>	<b>Style 12</b>

Pik Your Size						
Depth (mm)	Height (mm)					
	100	150	200	250	300	400
30	74.25	111.38	148.51	178.64	214.37	285.82
45	77.81	116.72	149.76	187.20	224.64	287.79
60	81.37	122.06	156.61	195.76	234.91	300.95

\*Style not available in 50mm high

30	77.81	116.72	149.76	187.20	224.64	287.79
45	79.24	118.85	152.50	190.62	228.75	293.06
60	84.93	127.39	163.46	204.32	245.19	314.11

Manufacturer's recommended prices exclude VAT

Pik Your Options			
Applications		Fixings	
Internal	External	Tape	Stud
✓	-	-	✓
✓	-	-	✓
✓	-	-	✓
✓	-	-	✓

Note: The depth of the product includes the metal and illuminated acrylic. The illuminated section is a third of the depth of the finished letter. Pricing is per letter based on the tallest letter in the sentence or word. Above prices are manufacturer's recommended retail prices excluding VAT and include a one year guarantee.

Estimated lead time is 3 weeks from order.

#### Pricing includes

- Fitting Template
- Choice of fixings
- Applelec quality inspection

#### See your specialist distributor for:

- Bespoke options
- Installation advice
- Delivery options
- A full quotation



# Polished Stainless Steel



Polished Stainless Steel Halo Illuminated - Style 1



A smooth & bright polished stainless steel finish.



The letter surface is enhanced by the halo effect.



Illumination is available in two colour temperatures – 3000K warm white and 5000K cool white.

Pik Your Style	
Styles available Range Code: ILU-IHL-SLS-POL-BLO	
<b>Style 1</b>	<b>Style 4</b>
Style 2*	<b>STYLE 5</b>
Style 3*	<b>Style 6</b>
Range Code: ILU-IHL-SLS-POL-SER	
<b>Style 7</b>	<b>Style 10</b>
Style 8	<b>STYLE 11</b>
<b>Style 9</b>	<b>Style 12</b>

Pik Your Size						
Depth (mm)	Height (mm)					
	100	150	200	250	300	400
30	65.48	98.21	130.95	157.52	189.03	252.03
45	69.03	103.55	138.07	166.08	199.30	265.73
60	72.59	108.89	145.19	174.64	209.57	279.43
*Style not available in 50mm high						
30	69.03	103.55	138.07	166.08	199.30	265.73
45	72.59	108.89	145.19	174.64	209.57	279.43
60	76.15	114.23	152.30	183.20	219.85	293.13
Manufacturer's recommended prices exclude VAT						

Pik Your Options			
Applications		Fixings	
Internal	External	Tape	Stud
✓	-	-	✓
✓	-	-	✓
✓	-	-	✓
✓	-	-	✓
✓	-	-	✓
✓	-	-	✓

Note: The depth of the product includes the metal and illuminated acrylic. The illuminated section is a third of the depth of the finished letter. Pricing is per letter based on the tallest letter in the sentence or word. Above prices are manufacturer's recommended retail prices excluding VAT and include a one year guarantee.

Estimated lead time is 3 weeks from order.

**Pricing includes**  
 Fitting Template  
 Choice of fixings  
 Applelec quality inspection

**See your specialist distributor for:**  
 Bespoke options  
 Installation advice  
 Delivery options  
 A full quotation



# Brushed Stainless Steel

A textured brushed stainless steel finish.



The letter surface is enhanced by the halo effect.



Illumination is available in two colour temperatures – 3000K warm white and 5000K cool white.



Brushed Stainless Steel Halo Illuminated - Style 1

Pik Your Style	
Styles available Range Code: ILU-IHL-SLS-BSH-BLO	
<b>Style 1</b>	<b>Style 4</b>
Style 2*	<b>STYLE 5</b>
Style 3*	<b>Style 6</b>
Range Code: ILU-IHL-SLS-BSH-SER	
<b>Style 7</b>	<b>Style 10</b>
Style 8	<b>STYLE 11</b>
<b>Style 9</b>	<b>Style 12</b>

Pik Your Size						
Depth (mm)	Height (mm)					
	100	150	200	250	300	400
30	63.82	95.72	127.63	153.53	184.23	245.64
45	67.37	101.06	134.75	162.09	194.51	259.34
60	70.93	106.40	141.86	170.65	204.78	273.04

\*Style not available in 50mm high

30	67.37	101.06	134.75	162.09	194.51	259.34
45	70.93	106.40	141.86	170.65	204.78	273.04
60	74.25	111.38	148.51	178.64	214.37	285.82

Manufacturer's recommended prices exclude VAT

Pik Your Options			
Applications		Fixings	
Internal	External	Tape	Stud
✓	-	-	✓
✓	-	-	✓
✓	-	-	✓
✓	-	-	✓

Note: The depth of the product includes the metal and illuminated acrylic. The illuminated section is a third of the depth of the finished letter. Pricing is per letter based on the tallest letter in the sentence or word. Above prices are manufacturer's recommended retail prices excluding VAT and include a one year guarantee.

Estimated lead time is 3 weeks from order.

#### Pricing includes

- Fitting Template
- Choice of fixings
- Applelec quality inspection

#### See your specialist distributor for:

- Bespoke options
- Installation advice
- Delivery options
- A full quotation



# Gold Effect Polished



Gold Effect Polished Halo Illuminated - Style 1

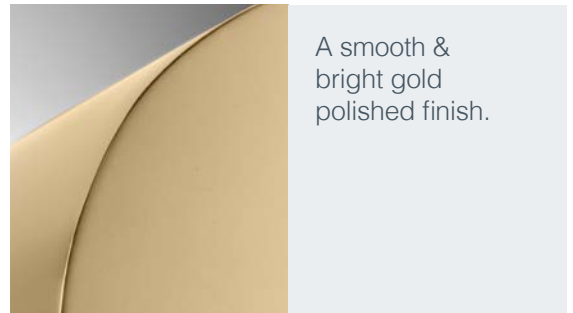

A smooth & bright gold polished finish.

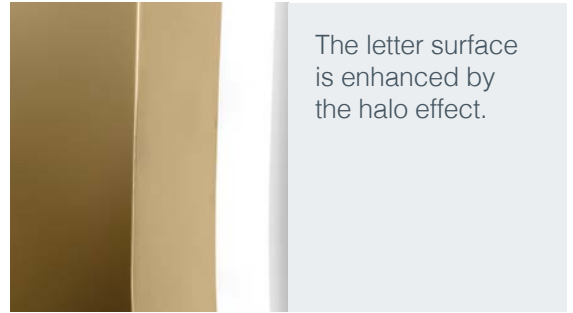

The letter surface is enhanced by the halo effect.



Illumination is available in two colour temperatures – 3000K warm white and 5000K cool white.

Pik Your Style	
Styles available Range Code: ILU-IHL-GLD-POL-BLO	
<b>Style 1</b>	<b>Style 4</b>
Style 2*	<b>STYLE 5</b>
Style 3*	<b>Style 6</b>
Range Code: ILU-IHL-GLD-POL-SER	
<b>Style 7</b>	<b>Style 10</b>
Style 8	<b>STYLE 11</b>
<b>Style 9</b>	<b>Style 12</b>

Pik Your Size						
Depth (mm)	Height (mm)					
	100	150	200	250	300	400
30	76.15	114.23	152.30	183.20	219.85	293.13
45	79.71	119.56	153.41	191.77	230.12	294.81
60	83.27	124.90	160.26	200.33	240.39	307.97
*Style not available in 50mm high						
30	79.71	119.56	153.41	191.77	230.12	294.81
45	83.27	124.90	160.26	200.33	240.39	307.97
60	86.83	130.24	167.11	208.89	250.67	321.13
Manufacturer's recommended prices exclude VAT						

Pik Your Options			
Applications		Fixings	
Internal	External	Tape	Stud
✓	-	-	✓
✓	-	-	✓
✓	-	-	✓
✓	-	-	✓
✓	-	-	✓

Note: The depth of the product includes the metal and illuminated acrylic. The illuminated section is a third of the depth of the finished letter. Pricing is per letter based on the tallest letter in the sentence or word. Above prices are manufacturer's recommended retail prices excluding VAT and include a one year guarantee.

Estimated lead time is 3 weeks from order.

#### Pricing includes

- Fitting Template
- Choice of fixings
- Applelec quality inspection

#### See your specialist distributor for:

- Bespoke options
- Installation advice
- Delivery options
- A full quotation



# Gold Effect Brushed

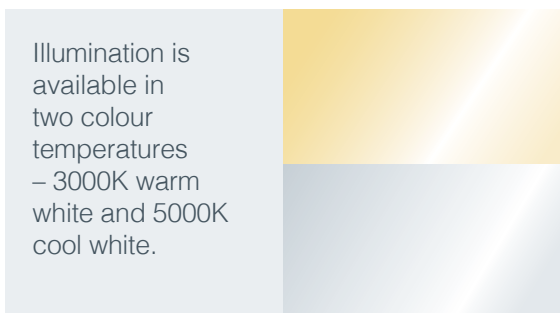
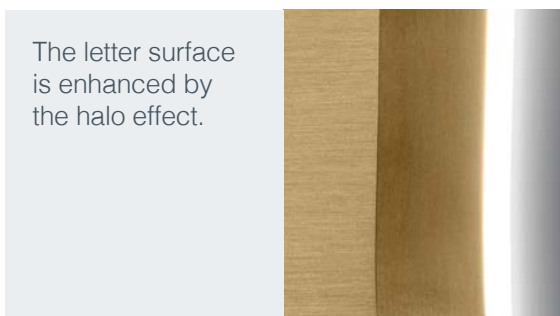
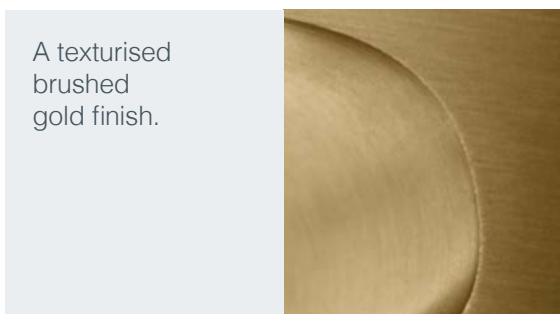

Pik Your Style	
Styles available Range Code: ILU-IHL-GLD-BHS-BLO	
<b>Style 1</b>	<b>Style 4</b>
Style 2*	<b>STYLE 5</b>
Style 3*	<b>Style 6</b>
Range Code: ILU-IHL-GLD-BHS-SER	
<b>Style 7</b>	<b>Style 10</b>
Style 8	<b>STYLE 11</b>
<b>Style 9</b>	<b>Style 12</b>

Pik Your Size						
Depth (mm)	Height (mm)					
	100	150	200	250	300	400
30	74.25	111.38	148.51	178.64	214.37	285.82
45	77.81	116.72	149.76	187.20	224.64	287.79
60	81.37	122.06	156.61	195.76	234.91	300.95
*Style not available in 50mm high						
30	77.81	116.72	149.76	187.20	224.64	287.79
45	81.37	122.06	156.61	195.76	234.91	300.95
60	84.93	127.39	163.46	204.32	245.19	314.11
Manufacturer's recommended prices exclude VAT						

Pik Your Options			
Applications		Fixings	
Internal	External	Tape	Stud
✓	-	-	✓
✓	-	-	✓
✓	-	-	✓
✓	-	-	✓
✓	-	-	✓

Note: The depth of the product includes the metal and illuminated acrylic. The illuminated section is a third of the depth of the finished letter. Pricing is per letter based on the tallest letter in the sentence or word. Above prices are manufacturer's recommended retail prices excluding VAT and include a one year guarantee.

Estimated lead time is 3 weeks from order.

#### Pricing includes

- Fitting Template
- Choice of fixings
- Applelec quality inspection

#### See your specialist distributor for:

- Bespoke options
- Installation advice
- Delivery options
- A full quotation

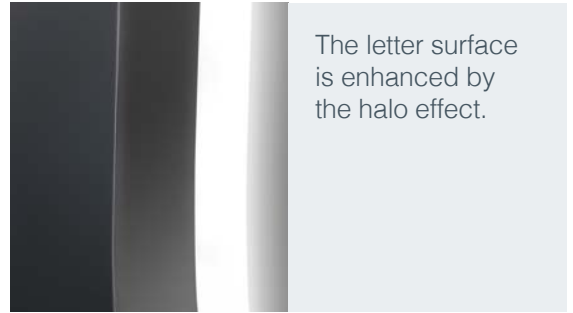
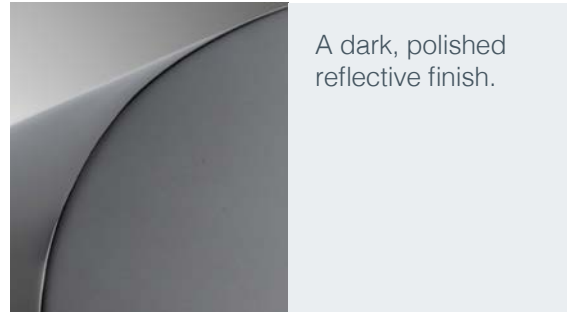

Pik Your Style	
Styles available Range Code: ILU-IHL-OBS-POL-BLO	
<b>Style 1</b>	<b>Style 4</b>
Style 2*	<b>STYLE 5</b>
Style 3*	<b>Style 6</b>
Range Code: ILU-IHL-OBS-POL-SER	
<b>Style 7</b>	<b>Style 10</b>
Style 8	<b>STYLE 11</b>
<b>Style 9</b>	<b>Style 12</b>

Pik Your Size						
Depth (mm)	Height (mm)					
	100	150	200	250	300	400
30	76.15	114.23	152.30	183.20	219.85	293.13
45	79.71	119.56	153.41	191.77	230.12	294.81
60	83.27	124.90	160.26	200.33	240.39	307.97
*Style not available in 50mm high						
30	79.71	119.56	153.41	191.77	230.12	294.81
45	83.27	124.90	160.26	200.33	240.39	307.97
60	86.83	130.24	167.11	208.89	250.67	321.13
Manufacturer's recommended prices exclude VAT						

Pik Your Options			
Applications		Fixings	
Internal	External	Tape	Stud
✓	-	-	✓
✓	-	-	✓
✓	-	-	✓
✓	-	-	✓
✓	-	-	✓
✓	-	-	✓

Note: The depth of the product includes the metal and illuminated acrylic. The illuminated section is a third of the depth of the finished letter. Pricing is per letter based on the tallest letter in the sentence or word. Above prices are manufacturer's recommended retail prices excluding VAT and include a one year guarantee.

Estimated lead time is 3 weeks from order.

#### Pricing includes

- Fitting Template
- Choice of fixings
- Applelec quality inspection

#### See your specialist distributor for:

- Bespoke options
- Installation advice
- Delivery options
- A full quotation



The letter surface is enhanced by the halo effect.



Available in a choice of RAL colours. Please refer to page 76.



Illumination is available in two colour temperatures – 3000K warm white and 5000K cool white.

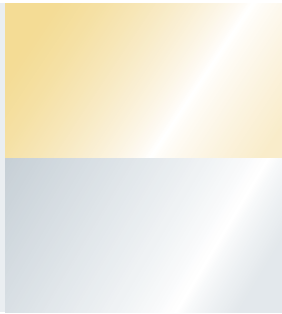

Painted Halo Illuminated - Style 1

Pik Your Style	
Styles available Range Code: ILU-IHL-SLS-PNT-BLO	
<b>Style 1</b>	<b>Style 4</b>
Style 2*	<b>STYLE 5</b>
Style 3*	<b>Style 6</b>
Range Code: ILU-IHL-SLS-PNT-SER	
<b>Style 7</b>	<b>Style 10</b>
Style 8	<b>STYLE 11</b>
<b>Style 9</b>	<b>Style 12</b>

Pik Your Size						
Depth (mm)	Height (mm)					
	100	150	200	250	300	400
30	65.48	98.21	130.95	157.52	189.03	252.03
45	69.03	103.55	138.07	166.08	199.30	265.73
60	72.59	108.89	145.19	174.64	209.57	279.43
*Style not available in 50mm high						
30	69.03	103.55	138.07	166.08	199.30	265.73
45	72.59	108.89	145.19	174.64	209.57	279.43
60	76.15	114.23	152.30	183.20	219.85	293.13

Manufacturer's recommended prices exclude VAT

Pik Your Options			
Applications		Fixings	
Internal	External	Tape	Stud
✓	-	-	✓
✓	-	-	✓
✓	-	-	✓
✓	-	-	✓

Note: The depth of the product includes the metal and illuminated acrylic. The illuminated section is a third of the depth of the finished letter. Pricing is per letter based on the tallest letter in the sentence or word. Above prices are manufacturer's recommended retail prices excluding VAT and include a one year guarantee.

Estimated lead time is 3 weeks from order.

#### Pricing includes

- Fitting Template
- Choice of fixings
- Applelec quality inspection

#### See your specialist distributor for:

- Bespoke options
- Installation advice
- Delivery options
- A full quotation



---

# Neon Finishes

This beautifully striking effect removes the risks associated with traditional neon signs. Applelec SignPik neon signs are low voltage, safe to touch, easy to install and robust.

This option offers the glass tube appearance of clear or frosted retro neon lighting. The rounded face of the lettering gives a crystalline illusion to the eye, retaining that retro neon style. This is further enhanced by the light refraction of the oval prism face, transferred from the energy efficient LED light source.



---

# Clear Glass Neon Effect

The clarity of light and impact of the Applelec SignPik clear neon effect is as eye-catching as it is distinctive. The rounded, polished clear acrylic face beautifully achieves a neon effect.



A striking retro clear glass neon style.



The dark, polished, reflective obsidian complements the neon.



Illumination is available in two colour temperatures – 3000K warm white and 5000K cool white.

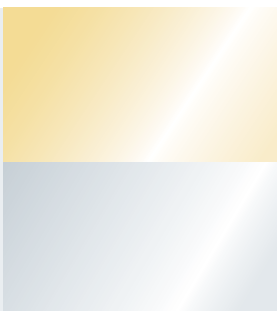

Obsidian Clear Neon Illuminated - Style 14

Pik Your Style
<p>Styles available Range Code: NEO-CLR-OBS-POL-NE2</p>
<b>Style 13</b>
<p>Range Code: NEO-CLR-OBS-POL-NEO</p>
<b>Style 14</b>

Depth (mm)	Pik Your Size			
	Height (mm)			
	100	150	200	250
30	77.83	98.88		
45	78.55	99.97		
60	78.98	100.62		
30		98.88	119.94	137.02
45		99.97	121.38	138.77
60		100.62	122.25	139.81

Manufacturer's recommended prices exclude VAT

Pik Your Options			
Applications		Fixings	
Internal	External	Tape	Stud
✓	-	-	✓
✓	-	-	✓
✓	-	-	✓
✓	-	-	✓
✓	-	-	✓
✓	-	-	✓

Note: Pricing is per letter based on the tallest letter in the sentence or word. Above prices are manufacturer's recommended retail prices excluding VAT and include a one year guarantee.

Estimated lead time is 3 weeks from order.

**Pricing includes**  
 Fitting Template  
 Choice of fixings  
 Applelec quality inspection

**See your specialist distributor for:**  
 Bespoke options  
 Installation advice  
 Delivery options  
 A full quotation



# Polished Rose Gold



Polished Rose Gold Clear Neon Illuminated - Style 14



A striking retro clear glass neon style.



The warm rosy hue of the rose gold enhances the illuminated face.



Illumination is available in two colour temperatures – 3000K warm white and 5000K cool white.

034 | Neon Finishes: Clear

Pik Your Style
Styles available Range Code: NEO-CLR-RSG-POL-NE2
<b>Style 13</b>
Range Code: NEO-CLR-RSG-POL-NEO
<b>Style 14</b>

Depth (mm)	Pik Your Size			
	Height (mm)			
	100	150	200	250
30	77.83	98.88		
45	78.55	99.97		
60	78.98	100.62		
30		98.88	119.94	137.02
45		99.97	121.38	138.77
60		100.62	122.25	139.81

Manufacturer's recommended prices exclude VAT

Pik Your Options		Applications		Fixings	
Internal	External	Tape	Stud		
✓	-	-	✓		
✓	-	-	✓		
✓	-	-	✓		
✓	-	-	✓		
✓	-	-	✓		
✓	-	-	✓		

Note: Pricing is per letter based on the tallest letter in the sentence or word. Above prices are manufacturer's recommended retail prices excluding VAT and include a one year guarantee.

Estimated lead time is 3 weeks from order.

#### Pricing includes

- Fitting Template
- Choice of fixings
- Applelec quality inspection

#### See your specialist distributor for:

- Bespoke options
- Installation advice
- Delivery options
- A full quotation



# Brushed Rose Gold

A striking retro clear glass neon style.



The brushed rose gold provides a warm finish to the neon lettering.



Illumination is available in two colour temperatures – 3000K warm white and 5000K cool white.

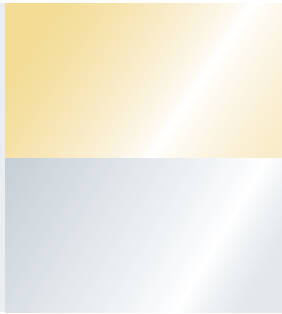

Brushed Rose Gold Clear Neon Illuminated - Style 14

Pik Your Style
<p>Styles available Range Code: NEO-CLR-RSG-BSH-NE2</p> <p><b>Style 13</b></p> <p>Range Code: NEO-CLR-RSG-BSH-NEO</p>
<b>Style 14</b>

Depth (mm)	Pik Your Size			
	Height (mm)			
	100	150	200	250
30	76.81	97.36		
45	77.39	98.23		
60	77.83	98.88		
30		97.36	117.91	134.59
45		98.23	119.07	135.98
60		98.88	119.94	137.02

Manufacturer's recommended prices exclude VAT

Pik Your Options		Applications		Fixings	
Internal	External	Tape	Stud		
✓	-	-	✓		
✓	-	-	✓		
✓	-	-	✓		
✓	-	-	✓		
✓	-	-	✓		
✓	-	-	✓		

Note: Pricing is per letter based on the tallest letter in the sentence or word. Above prices are manufacturer's recommended retail prices excluding VAT and include a one year guarantee.

Estimated lead time is 3 weeks from order.

#### Pricing includes

- Fitting Template
- Choice of fixings
- Applelec quality inspection

#### See your specialist distributor for:

- Bespoke options
- Installation advice
- Delivery options
- A full quotation





# Copper Effect Polished



Copper Effect Polished Clear Neon Illuminated - Style 14



A striking retro clear glass neon style.



The polished copper creates a beautifully nostalgic finish.



Illumination is available in two colour temperatures – 3000K warm white and 5000K cool white.

036 | Neon Finishes: Clear

Pik Your Style
Styles available Range Code: NEO-CLR-COP-POL-NE2
<b>Style 13</b>
Range Code: NEO-CLR-COP-POL-NEO <b>Style 14</b>

Depth (mm)	Pik Your Size			
	Height (mm)			
	100	150	200	250
30	77.83	98.88		
45	78.55	99.97		
60	78.98	100.62		
30		98.88	119.94	137.02
45		99.97	121.38	138.77
60		100.62	122.25	139.81

Manufacturer's recommended prices exclude VAT

Pik Your Options		Applications		Fixings	
Internal	External	Tape	Stud		
✓	-	-	✓		
✓	-	-	✓		
✓	-	-	✓		
✓	-	-	✓		
✓	-	-	✓		
✓	-	-	✓		

Note: Pricing is per letter based on the tallest letter in the sentence or word. Above prices are manufacturer's recommended retail prices excluding VAT and include a one year guarantee.

Estimated lead time is 3 weeks from order.

#### Pricing includes

- Fitting Template
- Choice of fixings
- Applelec quality inspection

#### See your specialist distributor for:

- Bespoke options
- Installation advice
- Delivery options
- A full quotation





# Bronze Effect Brushed

A striking retro clear glass neon style.

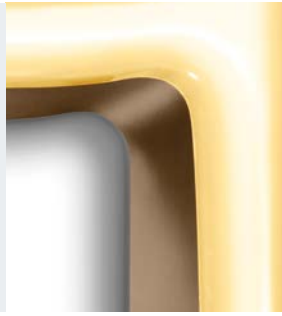

The bronze finish gives a feeling of heritage which is striking when combined with the neon effect.



Illumination is available in two colour temperatures – 3000K warm white and 5000K cool white.

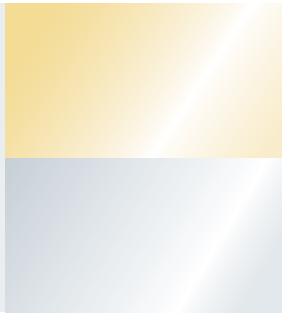

Bronze Effect Brushed Clear Neon Illuminated - Style 14

Pik Your Style
<p>Styles available Range Code: NEO-CLR-BNZ-BSH-NE2</p> <p><b>Style 13</b></p> <p>Range Code: NEO-CLR-BNZ-BSH-NEO</p> <p><b>Style 14</b></p>

Depth (mm)	Pik Your Size			
	Height (mm)			
	100	150	200	250
30	77.83	98.88		
45	78.55	99.97		
60	78.98	100.62		
30		98.88	119.94	137.02
45		99.97	121.38	138.77
60		100.62	122.25	139.81

Manufacturer's recommended prices exclude VAT

Pik Your Options		Applications		Fixings	
Internal	External	Tape	Stud		
✓	-	-	✓		
✓	-	-	✓		
✓	-	-	✓		
✓	-	-	✓		
✓	-	-	✓		
✓	-	-	✓		

Note: Pricing is per letter based on the tallest letter in the sentence or word. Above prices are manufacturer's recommended retail prices excluding VAT and include a one year guarantee.

Estimated lead time is 3 weeks from order.

### Pricing includes

- Fitting Template
- Choice of fixings
- Applelec quality inspection

### See your specialist distributor for:

- Bespoke options
- Installation advice
- Delivery options
- A full quotation



# Polished Stainless Steel



Polished Stainless Steel Clear Neon Illuminated - Style 14



A striking retro clear glass neon style.



The neon is enhanced with a smooth & bright stainless steel finish.



Illumination is available in two colour temperatures – 3000K warm white and 5000K cool white.

Neon Finishes: Clear

038

Pik Your Style
Styles available Range Code: NEO-CLR-SLS-POL-NE2
<b>Style 13</b>
Range Code: NEO-CLR-SLS-POL-NEO
<b>Style 14</b>

Depth (mm)	Pik Your Size			
	Height (mm)			
	100	150	200	250
30	71.31	89.11		
45	72.04	90.20		
60	72.47	90.85		
30		89.11	106.91	124.71
45		90.20	108.36	126.52
60		90.85	109.23	127.61

Manufacturer's recommended prices exclude VAT

Pik Your Options			
Applications		Fixings	
Internal	External	Tape	Stud
✓	-	-	✓
✓	-	-	✓
✓	-	-	✓
✓	-	-	✓
✓	-	-	✓
✓	-	-	✓

Note: Pricing is per letter based on the tallest letter in the sentence or word. Above prices are manufacturer's recommended retail prices excluding VAT and include a one year guarantee.

Estimated lead time is 3 weeks from order.

#### Pricing includes

- Fitting Template
- Choice of fixings
- Applelec quality inspection

#### See your specialist distributor for:

- Bespoke options
- Installation advice
- Delivery options
- A full quotation



# Brushed Stainless Steel

A striking retro clear glass neon style.



Enhanced with a textured brushed stainless steel finish.



Illumination is available in two colour temperatures – 3000K warm white and 5000K cool white.

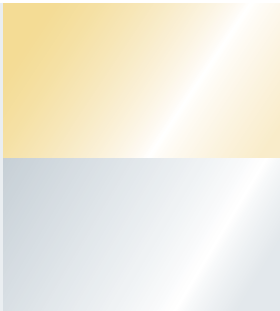

Brushed Stainless Steel Clear Neon Illuminated - Style 14

Pik Your Style
<p>Styles available Range Code: NEO-CLR-SLS-BSH-NE2</p> <p><b>Style 13</b></p> <p>Range Code: NEO-CLR-SLS-BSH-NEO</p> <p><b>Style 14</b></p>

Depth (mm)	Pik Your Size			
	Height (mm)			
	100	150	200	250
30	70.30	87.59		
45	70.88	88.46		
60	71.31	89.11		
30		87.59	104.89	122.18
45		88.46	106.04	123.63
60		89.11	106.91	124.71

Manufacturer's recommended prices exclude VAT

Pik Your Options			
Applications		Fixings	
Internal	External	Tape	Stud
✓	-	-	✓
✓	-	-	✓
✓	-	-	✓
✓	-	-	✓
✓	-	-	✓
✓	-	-	✓

Note: Pricing is per letter based on the tallest letter in the sentence or word. Above prices are manufacturer's recommended retail prices excluding VAT and include a one year guarantee.

Estimated lead time is 3 weeks from order.

#### Pricing includes

- Fitting Template
- Choice of fixings
- Applelec quality inspection

#### See your specialist distributor for:

- Bespoke options
- Installation advice
- Delivery options
- A full quotation



# Gold Effect Polished



Gold Effect Polished Clear Neon Illuminated - Style 14



A striking retro clear glass neon style.



The light from the neon is beautifully complemented by a polished gold finish.



Illumination is available in two colour temperatures – 3000K warm white and 5000K cool white.

040 | Neon Finishes: Clear

### Pik Your Style

Styles available  
Range Code: NEO-CLR-GLD-POL-NE2

#### Style 13

Range Code: NEO-CLR-GLD-POL-NEO

#### Style 14

### Pik Your Size

Depth (mm)	Height (mm)			
	100	150	200	250
30	77.83	98.88		
45	78.55	99.97		
60	78.98	100.62		
30		98.88	119.94	137.02
45		99.97	121.38	138.77
60		100.62	122.25	139.81

Manufacturer's recommended prices exclude VAT

### Pik Your Options

Applications		Fixings	
Internal	External	Tape	Stud
✓	-	-	✓
✓	-	-	✓
✓	-	-	✓
✓	-	-	✓
✓	-	-	✓
✓	-	-	✓

Note: Pricing is per letter based on the tallest letter in the sentence or word.  
Above prices are manufacturer's recommended retail prices excluding VAT and include a one year guarantee.

Estimated lead time is 3 weeks from order.

#### Pricing includes

- Fitting Template
- Choice of fixings
- Applelec quality inspection

#### See your specialist distributor for:

- Bespoke options
- Installation advice
- Delivery options
- A full quotation



# Gold Effect Brushed

A striking retro clear glass neon style.



The illuminated neon is enhanced with a classic gold tone with a non reflective textured finish.



Illumination is available in two colour temperatures – 3000K warm white and 5000K cool white.

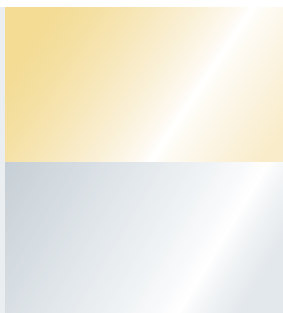

Gold Effect Brushed Clear Neon Illuminated - Style 14

041 | Neon Finishes: Clear

Pik Your Style
<p>Styles available Range Code: NEO-CLR-GLD-BSH-NE2</p> <p><b>Style 13</b></p> <p>Range Code: NEO-CLR-GLD-BSH-NEO</p>
<b>Style 14</b>

Depth (mm)	Pik Your Size			
	Height (mm)			
	100	150	200	250
30	76.81	97.36		
45	77.39	98.23		
60	77.83	98.88		
30		97.36	117.91	134.59
45		98.23	119.07	135.98
60		98.88	119.94	137.02

Manufacturer's recommended prices exclude VAT

Pik Your Options		Applications		Fixings	
Internal	External	Tape	Stud		
✓	-	-	✓		
✓	-	-	✓		
✓	-	-	✓		
✓	-	-	✓		
✓	-	-	✓		

Note: Pricing is per letter based on the tallest letter in the sentence or word. Above prices are manufacturer's recommended retail prices excluding VAT and include a one year guarantee.

Estimated lead time is 3 weeks from order.

**Pricing includes**

- Fitting Template
- Choice of fixings
- Applelec quality inspection

**See your specialist distributor for:**

- Bespoke options
- Installation advice
- Delivery options
- A full quotation



Painted Clear Neon Illuminated - Style 14



A striking retro clear glass neon style.



Available in a choice of RAL colours. Please refer to page 76.



A striking clear neon style.

Pik Your Style
<p>Styles available Range Code: NEO-CLR-SLS-PNT-NE2</p> <p><b>Style 13</b></p> <p>Range Code: NEO-CLR-SLS-PNT-NEO</p> <p><b>Style 14</b></p>

Depth (mm)	Pik Your Size			
	Height (mm)			
	100	150	200	250
30	70.30	87.59		
45	70.88	88.46		
60	71.31	89.11		
30		87.59	104.89	122.18
45		88.46	106.04	123.63
60		89.11	106.91	124.71

Manufacturer's recommended prices exclude VAT

Pik Your Options		Applications		Fixings	
Internal	External	Tape	Stud		
✓	-	-	✓		
✓	-	-	✓		
✓	-	-	✓		
✓	-	-	✓		
✓	-	-	✓		
✓	-	-	✓		

Note: Pricing is per letter based on the tallest letter in the sentence or word.  
Above prices are manufacturer's recommended retail prices excluding VAT and include a one year guarantee.

Estimated lead time is 3 weeks from order.

**Pricing includes**  
Fitting Template  
Choice of fixings  
Applelec quality inspection

**See your specialist distributor for:**  
Bespoke options  
Installation advice  
Delivery options  
A full quotation



---

# Frosted Glass Neon Effect

The diffused beauty of the frosted neon effect delivers the classic neon impact but with a sophisticated twist.







# Polished Rose Gold



Polished Rose Gold Frosted Neon Illuminated - Style 14

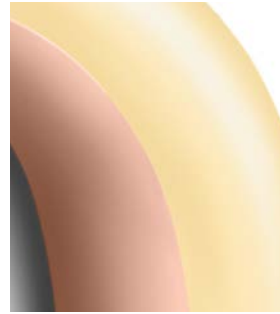

A warm rose hue with a polished finish.

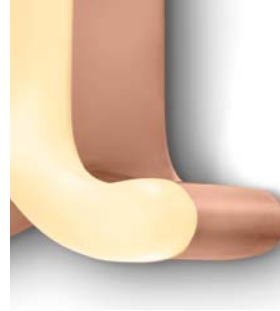

Precision laser cut technique produces a consistent finish across the letter.



Finish is lacquered for additional protection.

Neon Finishes: Frosted

044

Pik Your Style
<p>Styles available Range Code: NEO-FST-RSG-POL-NE2</p> <p><b>Style 13</b></p> <p>Range Code: NEO-FST-RSG-POL-NEO</p> <p><b>Style 14</b></p>

Depth (mm)	Pik Your Size			
	Height (mm)			
	100	150	200	250
30	77.83	98.88		
45	78.55	99.97		
60	78.98	100.62		
30		98.88	119.94	137.02
45		99.97	121.38	138.77
60		100.62	122.25	139.81

Manufacturer's recommended prices exclude VAT

Pik Your Options		Applications		Fixings	
Internal	External	Tape	Stud		
✓	-	-	✓		
✓	-	-	✓		
✓	-	-	✓		
✓	-	-	✓		
✓	-	-	✓		
✓	-	-	✓		

Note: Pricing is per letter based on the tallest letter in the sentence or word.  
Above prices are manufacturer's recommended retail prices excluding VAT and include a one year guarantee.

Estimated lead time is 3 weeks from order.

**Pricing includes**

- Fitting Template
- Choice of fixings
- Applelec quality inspection

**See your specialist distributor for:**

- Bespoke options
- Installation advice
- Delivery options
- A full quotation



# Brushed Rose Gold

A warm rose hue with a brushed finish.



Precision laser cut technique produces a consistent finish across the letter.



Finish is lacquered for additional protection.



Brushed Rose Gold Frosted Neon Illuminated - Style 14

Pik Your Style
<p>Styles available Range Code: NEO-FST-RSG-BSH-NE2</p> <p><b>Style 13</b></p> <p>Range Code: NEO-FST-RSG-BSH-NEO</p>
<b>Style 14</b>

Depth (mm)	Pik Your Size			
	Height (mm)			
	100	150	200	250
30	76.81	97.36		
45	77.39	98.23		
60	77.83	98.88		
30		97.36	117.91	134.59
45		98.23	119.07	135.98
60		98.88	119.94	137.02

Manufacturer's recommended prices exclude VAT

Pik Your Options		Applications		Fixings	
Internal	External	Tape	Stud		
✓	-	-	✓		
✓	-	-	✓		
✓	-	-	✓		
✓	-	-	✓		
✓	-	-	✓		
✓	-	-	✓		

Note: Pricing is per letter based on the tallest letter in the sentence or word. Above prices are manufacturer's recommended retail prices excluding VAT and include a one year guarantee.

Estimated lead time is 3 weeks from order.

**Pricing includes**

- Fitting Template
- Choice of fixings
- Applelec quality inspection

**See your specialist distributor for:**

- Bespoke options
- Installation advice
- Delivery options
- A full quotation



# Copper Effect Polished



Copper Effect Polished Frosted Neon Illuminated - Style 14



A soft attractive glow is created through frosted neon.



The neon is enhanced with the polished copper finish to create a beautifully nostalgic effect.



Illumination is available in two colour temperatures – 3000K warm white and 5000K cool white.

Pik Your Style
<p>Styles available Range Code: NEO-FST-COP-POL-NE2</p> <p><b>Style 13</b></p> <p>Range Code: NEO-FST-COP-POL-NEO</p> <p><b>Style 14</b></p>

Depth (mm)	Pik Your Size			
	Height (mm)			
	100	150	200	250
30	77.83	98.88		
45	78.55	99.97		
60	78.98	100.62		
30		98.88	119.94	137.02
45		99.97	121.38	138.77
60		100.62	122.25	139.81

Manufacturer's recommended prices exclude VAT

Pik Your Options		Applications		Fixings	
Internal	External	Tape	Stud		
✓	-	-	✓		
✓	-	-	✓		
✓	-	-	✓		
✓	-	-	✓		
✓	-	-	✓		
✓	-	-	✓		

Note: Pricing is per letter based on the tallest letter in the sentence or word. Above prices are manufacturer's recommended retail prices excluding VAT and include a one year guarantee.

Estimated lead time is 3 weeks from order.

**Pricing includes**

- Fitting Template
- Choice of fixings
- Applelec quality inspection

**See your specialist distributor for:**

- Bespoke options
- Installation advice
- Delivery options
- A full quotation



# Bronze Effect Brushed

A soft attractive glow is created through frosted neon.



The bronze finish gives a feeling of heritage which is striking when combined with the neon effect.



Illumination is available in two colour temperatures – 3000K warm white and 5000K cool white.

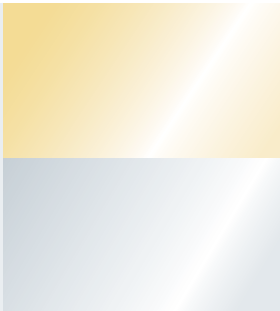

Bronze Effect Brushed Frosted Neon Illuminated - Style 14

Pik Your Style
<p>Styles available Range Code: NEO-FST-BNZ-BSH-NE2</p> <p><b>Style 13</b></p> <p>Range Code: NEO-FST-BNZ-BSH-NEO</p> <p><b>Style 14</b></p>

Depth (mm)	Pik Your Size			
	Height (mm)			
	100	150	200	250
30	77.83	98.88		
45	78.55	99.97		
60	78.98	100.62		
30		98.88	119.94	137.02
45		99.97	121.38	138.77
60		100.62	122.25	139.81

Manufacturer's recommended prices exclude VAT

Pik Your Options			
Applications		Fixings	
Internal	External	Tape	Stud
✓	-	-	✓
✓	-	-	✓
✓	-	-	✓
✓	-	-	✓
✓	-	-	✓
✓	-	-	✓

Note: Pricing is per letter based on the tallest letter in the sentence or word. Above prices are manufacturer's recommended retail prices excluding VAT and include a one year guarantee.

Estimated lead time is 3 weeks from order.

**Pricing includes**

- Fitting Template
- Choice of fixings
- Applelec quality inspection

**See your specialist distributor for:**

- Bespoke options
- Installation advice
- Delivery options
- A full quotation



# Polished Stainless Steel



Polished Stainless Steel Frosted Neon Illuminated - Style 14



A soft attractive glow is created through frosted neon.



The neon is enhanced by the smooth & bright stainless steel finish.



Illumination is available in two colour temperatures – 3000K warm white and 5000K cool white.

Neon Finishes: Frosted

048 |

Pik Your Style
Styles available Range Code: NEO-FST-SLS-POL-NE2
<b>Style 13</b>
Range Code: NEO-FST-SLS-POL-NEO
<b>Style 14</b>

Depth (mm)	Pik Your Size			
	Height (mm)			
	100	150	200	250
30	71.31	89.11		
45	72.04	90.20		
60	72.47	90.85		
30		89.11	106.91	124.71
45		90.20	108.36	126.52
60		90.85	109.23	127.61

Manufacturer's recommended prices exclude VAT

Pik Your Options		Applications		Fixings	
Internal	External	Tape	Stud		
✓	-	-	✓		
✓	-	-	✓		
✓	-	-	✓		
✓	-	-	✓		
✓	-	-	✓		
✓	-	-	✓		

Note: Pricing is per letter based on the tallest letter in the sentence or word. Above prices are manufacturer's recommended retail prices excluding VAT and include a one year guarantee.

Estimated lead time is 3 weeks from order.

#### Pricing includes

- Fitting Template
- Choice of fixings
- Applelec quality inspection

#### See your specialist distributor for:

- Bespoke options
- Installation advice
- Delivery options
- A full quotation



# Brushed Stainless Steel

A soft attractive glow is created through frosted neon.



The brushed stainless steel and frosted neon complement each other to create an eye-catching impact.



Illumination is available in two colour temperatures – 3000K warm white and 5000K cool white.

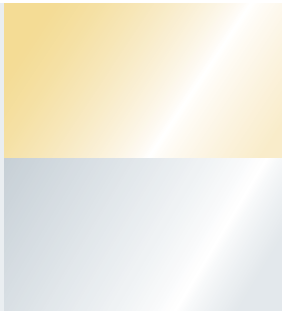

Brushed Stainless Steel Frosted Neon Illuminated - Style 14

Pik Your Style
<p>Styles available Range Code: NEO-FST-SLS-BSH-NE2</p> <p><b>Style 13</b></p> <p>Range Code: NEO-FST-SLS-BSH-NEO</p> <p><b>Style 14</b></p>

Depth (mm)	Pik Your Size			
	Height (mm)			
	100	150	200	250
30	70.30	87.59		
45	70.88	88.46		
60	71.31	89.11		
30		87.59	104.89	122.18
45		88.46	106.04	123.63
60		89.11	106.91	124.71

Manufacturer's recommended prices exclude VAT

Pik Your Options		Applications		Fixings	
Internal	External	Tape	Stud		
✓	-	-	✓		
✓	-	-	✓		
✓	-	-	✓		
✓	-	-	✓		
✓	-	-	✓		
✓	-	-	✓		

Note: Pricing is per letter based on the tallest letter in the sentence or word. Above prices are manufacturer's recommended retail prices excluding VAT and include a one year guarantee.

Estimated lead time is 3 weeks from order.

### Pricing includes

- Fitting Template
- Choice of fixings
- Applelec quality inspection

### See your specialist distributor for:

- Bespoke options
- Installation advice
- Delivery options
- A full quotation



# Gold Effect Polished



Gold Effect Polished Frosted Neon Illuminated - Style 14



A soft attractive glow is created through frosted neon.



The elegant polished gold finish creates a striking impact when combined with the neon.



Illumination is available in two colour temperatures – 3000K warm white and 5000K cool white.

Neon Finishes: Frosted

050

Pik Your Style
Styles available Range Code: NEO-FST-GLD-POL-NE2
<b>Style 13</b>
Range Code: NEO-FST-GLD-POL-NEO
<b>Style 14</b>

Depth (mm)	Pik Your Size			
	Height (mm)			
	100	150	200	250
30	77.83	98.88		
45	78.55	99.97		
60	78.98	100.62		
30		98.88	119.94	137.02
45		99.97	121.38	138.77
60		100.62	122.25	139.81

Manufacturer's recommended prices exclude VAT

Pik Your Options			
Applications		Fixings	
Internal	External	Tape	Stud
✓	-	-	✓
✓	-	-	✓
✓	-	-	✓
✓	-	-	✓
✓	-	-	✓
✓	-	-	✓

Note: Pricing is per letter based on the tallest letter in the sentence or word. Above prices are manufacturer's recommended retail prices excluding VAT and include a one year guarantee.

Estimated lead time is 3 weeks from order.

#### Pricing includes

- Fitting Template
- Choice of fixings
- Applelec quality inspection

#### See your specialist distributor for:

- Bespoke options
- Installation advice
- Delivery options
- A full quotation





# Gold Effect Brushed

A soft attractive glow is created through frosted neon.



The neon is enhanced with a classic gold non-reflective textured finish.



Illumination is available in two colour temperatures – 3000K warm white and 5000K cool white.

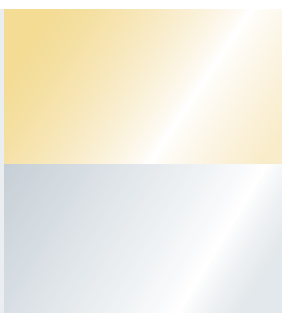

Gold Effect Brushed Frosted Neon Illuminated - Style 14

Pik Your Style
<p>Styles available Range Code: NEO-FST-GLD-BSH-NE2</p> <p><b>Style 13</b></p> <p>Range Code: NEO-FST-GLD-BSH-NEO</p>
<b>Style 14</b>

Depth (mm)	Pik Your Size			
	Height (mm)			
	100	150	200	250
30	76.81	97.36		
45	77.39	98.23		
60	77.83	98.88		
30		97.36	117.91	134.59
45		98.23	119.07	135.98
60		98.88	119.94	137.02

Manufacturer's recommended prices exclude VAT

Pik Your Options		Applications		Fixings	
Internal	External	Tape	Stud		
✓	-	-	✓		
✓	-	-	✓		
✓	-	-	✓		
✓	-	-	✓		
✓	-	-	✓		
✓	-	-	✓		

Note: Pricing is per letter based on the tallest letter in the sentence or word.  
Above prices are manufacturer's recommended retail prices excluding VAT and include a one year guarantee.

Estimated lead time is 3 weeks from order.

**Pricing includes**

- Fitting Template
- Choice of fixings
- Applelec quality inspection

**See your specialist distributor for:**

- Bespoke options
- Installation advice
- Delivery options
- A full quotation



Obsidian Frosted Neon Illuminated - Style 14



A soft attractive glow is created through frosted neon.



The obsidian finish is both elegant & beautiful, combined with neon to create a notable finish.



Illumination is available in two colour temperatures – 3000K warm white and 5000K cool white.

Pik Your Style
<p>Styles available Range Code: NEO-FST-OBS-POL-NE2</p>
<b>Style 13</b>
<p>Range Code: NEO-FST-OBS-POL-NEO</p>
<b>Style 14</b>

Depth (mm)	Pik Your Size			
	Height (mm)			
	100	150	200	250
30	77.83	98.88		
45	78.55	99.97		
60	78.98	100.62		
30		98.88	119.94	137.02
45		99.97	121.38	138.77
60		100.62	122.25	139.81

Manufacturer's recommended prices exclude VAT

Pik Your Options		Applications		Fixings	
Internal	External	Tape	Stud		
✓	-	-	✓		
✓	-	-	✓		
✓	-	-	✓		
✓	-	-	✓		
✓	-	-	✓		
✓	-	-	✓		

Note: Pricing is per letter based on the tallest letter in the sentence or word.  
Above prices are manufacturer's recommended retail prices excluding VAT and include a one year guarantee.

Estimated lead time is 3 weeks from order.

**Pricing includes**  
 Fitting Template  
 Choice of fixings  
 Applelec quality inspection

**See your specialist distributor for:**  
 Bespoke options  
 Installation advice  
 Delivery options  
 A full quotation

The neon colour is matched to the painted finish.

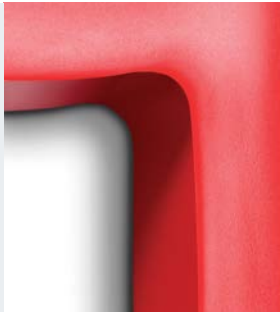

Available in a choice of RAL colours. Please refer to page 76.



Powder-coated stainless steel produces a consistent, high quality finish.



Painted Frosted Neon Illuminated - Style 14

Pik Your Style
<p>Styles available Range Code: NEO-FST-SLS-PNT-NE2</p> <p><b>Style 13</b></p> <p>Range Code: NEO-FST-SLS-PNT-NE0</p>
<b>Style 14</b>

Depth (mm)	Pik Your Size			
	Height (mm)			
	100	150	200	250
30	70.30	87.59		
45	70.88	88.46		
60	71.31	89.11		
30		87.59	104.89	122.18
45		88.46	106.04	123.63
60		89.11	106.91	124.71

Manufacturer's recommended prices exclude VAT

Pik Your Options			
Applications		Fixings	
Internal	External	Tape	Stud
✓	-	-	✓
✓	-	-	✓
✓	-	-	✓
✓	-	-	✓
✓	-	-	✓
✓	-	-	✓

Note: Pricing is per letter based on the tallest letter in the sentence or word. Above prices are manufacturer's recommended retail prices excluding VAT and include a one year guarantee.

Estimated lead time is 3 weeks from order.

**Pricing includes**

- Fitting Template
- Choice of fixings
- Applelec quality inspection

**See your specialist distributor for:**

- Bespoke options
- Installation advice
- Delivery options
- A full quotation

---

# Metal Finishes

These classic designs deliver instant impact with the beautiful detail of their finish.

The polished edge of the flat-cut and blended edge of the built-up finish distinguishes the quality and elegance of the letters.







# Polished Rose Gold

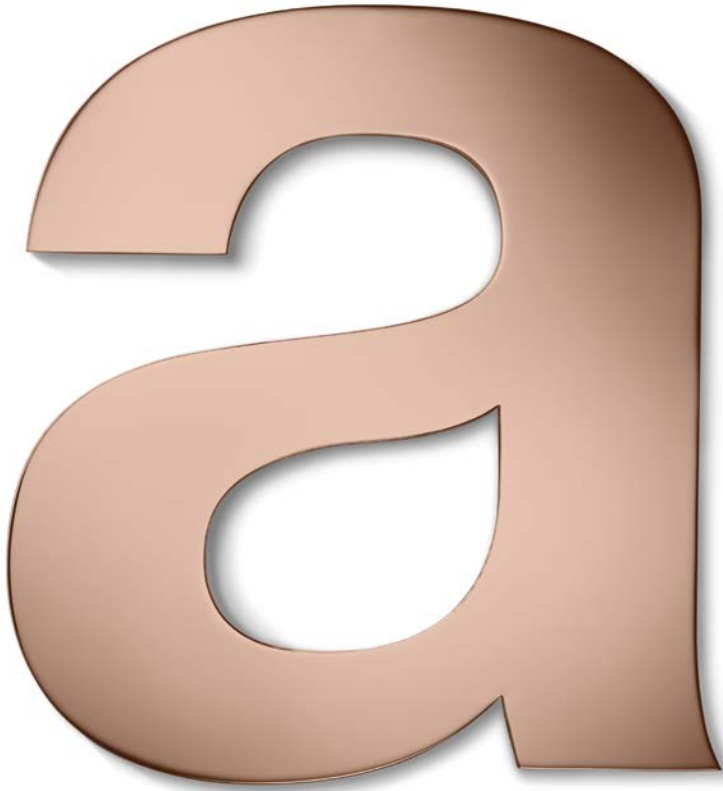

Polished Rose Gold Metal Finish - Style 1



A warm rose hue with a polished finish.

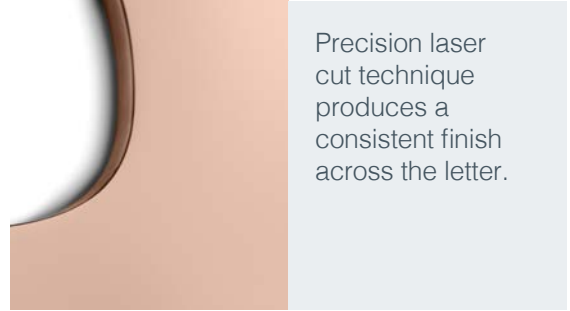

Precision laser cut technique produces a consistent finish across the letter.

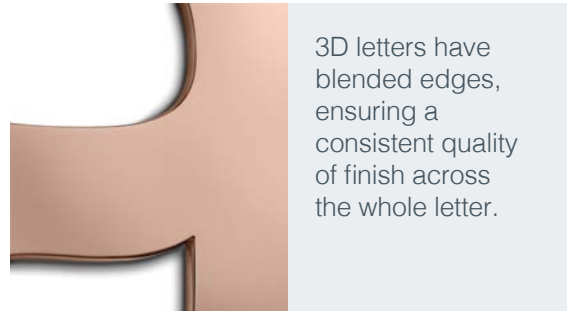

3D letters have blended edges, ensuring a consistent quality of finish across the whole letter.

Pik Your Style	
Styles available Range Code: LTR-SLD-RSG-POL-BLO	
<b>Style 1</b>	<b>Style 4</b>
Style 2	<b>STYLE 5</b>
Style 3	<b>Style 6</b>
Range Code: LTR-SLD-RSG-POL-SER	
<b>Style 7</b>	<b>Style 10</b>
Style 8	<b>STYLE 11</b>
<b>Style 9</b>	<b>Style 12</b>

Depth (mm)	Pik Your Size							
	Height (mm)							
	50	100	150	200	250	300	400	
1.5	15.44	25.17	34.89	44.62	54.35	61.22	77.81	
3	17.22	28.73	40.23	51.74	63.24	71.89	92.05	
5	18.05	30.39	42.72	55.06	67.39	76.87	98.69	
10	22.56	39.40	56.24	73.09	89.93	103.92	134.75	
20		41.98	52.25	62.53	72.80	83.08	109.81	
30		46.26	56.54	66.81	77.09	87.36	112.24	
45		50.13	60.91	71.70	82.48	93.26	114.82	
60		51.29	62.65	74.01	85.37	96.73	124.23	
1.5	15.44	25.17	34.89	44.62	54.35	61.22	77.81	
3	17.22	28.73	40.23	51.74	63.24	71.89	92.05	
5	18.05	30.39	42.72	55.06	67.39	76.87	98.69	
10	23.39	41.06	58.74	76.41	94.08	108.90	141.39	
20		42.99	53.77	64.55	75.33	86.11	114.17	
30		47.28	58.06	68.84	79.62	90.40	116.50	
45		51.29	62.65	74.01	85.37	96.73	124.23	
60		52.30	64.17	76.04	87.90	99.77	124.73	

Manufacturer's recommended prices exclude VAT

Pik Your Options			
Applications		Fixings	
Internal	External	Tape	Stud
✓	✓	✓	✓
✓	✓	✓	✓
✓	✓	✓	✓
✓	✓	-	✓
✓	✓	-	✓
✓	✓	-	✓
✓	✓	-	✓
✓	✓	-	✓
✓	✓	-	✓
✓	✓	-	✓
✓	✓	-	✓
✓	✓	-	✓
✓	✓	-	✓

Note: Pricing is per letter based on the tallest letter in the sentence or word.  
 Above prices are manufacturer's recommended retail prices excluding VAT and include a one year guarantee.  
 For application within 1 mile of coastal areas, a 316 steel upgrade must be applied and could be subject to a surcharge.

Estimated lead time is 3 weeks from order.

**Pricing includes**

- Fitting Template
- Choice of fixings
- Applelec quality inspection

**See your specialist distributor for:**

- Bespoke options
- Installation advice
- Delivery options
- A full quotation





# Brushed Rose Gold

A warm rose hue with a brushed finish.



Finish is lacquered for additional protection.



3D letters have blended edges, ensuring a consistent quality of finish across the whole letter.



Brushed Rose Gold Metal Finish - Style 1

Pik Your Style	
Styles available Range Code: LTR-SLD-RSG-BSH-BLO	
<b>Style 1</b>	<b>Style 4</b>
Style 2	<b>STYLE 5</b>
Style 3	<b>Style 6</b>
Range Code: LTR-SLD-RSG-BSH-SER	
<b>Style 7</b>	<b>Style 10</b>
Style 8	<b>STYLE 11</b>
<b>Style 9</b>	<b>Style 12</b>

Pik Your Size							
Depth (mm)	Height (mm)						
	50	100	150	200	250	300	400
1.5	14.61	23.51	32.40	41.30	50.20	56.23	71.17
3	16.39	27.07	37.74	48.42	59.09	66.91	85.40
5	18.05	30.39	42.72	55.06	67.39	76.87	98.69
10	21.61	37.50	53.40	69.29	85.19	98.22	127.16
20		40.82	50.52	60.21	69.91	79.60	103.08
30		45.11	54.80	64.50	74.19	83.89	103.28
45		49.12	59.39	69.67	79.94	90.22	110.77
60		50.13	60.91	71.70	82.48	93.26	114.82
1.5	14.61	23.51	32.40	41.30	50.20	56.23	71.17
3	16.39	27.07	37.74	48.42	59.09	66.91	85.40
5	18.05	30.39	42.72	55.06	67.39	76.87	98.69
10	22.56	39.40	56.24	73.09	89.93	103.92	134.75
20		41.98	52.25	62.53	72.80	83.08	109.81
30		46.26	56.54	66.81	77.09	87.36	112.24
45		50.13	60.91	71.70	82.48	93.26	114.82
60		51.29	62.65	74.01	85.37	96.73	124.23

Manufacturer's recommended prices exclude VAT

Pik Your Options			
Applications		Fixings	
Internal	External	Tape	Stud
✓	✓	✓	✓
✓	✓	✓	✓
✓	✓	✓	✓
✓	✓	-	✓
✓	✓	-	✓
✓	✓	-	✓
✓	✓	-	✓
✓	✓	-	✓
✓	✓	-	✓
✓	✓	-	✓
✓	✓	✓	✓
✓	✓	✓	✓
✓	✓	✓	✓
✓	✓	-	✓
✓	✓	-	✓
✓	✓	-	✓

Note: Pricing is per letter based on the tallest letter in the sentence or word. Above prices are manufacturer's recommended retail prices excluding VAT and include a one year guarantee. For application within 1 mile of coastal areas, a 316 steel upgrade must be applied and could be subject to a surcharge.

Estimated lead time is 3 weeks from order.

**Pricing includes**  
Fitting Template  
Choice of fixings  
Applelec quality inspection

**See your specialist distributor for:**  
Bespoke options  
Installation advice  
Delivery options  
A full quotation





# Copper Effect Polished



Copper Effect Polished Metal Finish - Style 1

A beautiful nostalgic polished finish.

Precision laser cut technique produces a consistent finish across the letter.

3D letters have blended edges, ensuring a consistent quality of finish across the whole letter.

Pik Your Style	
Styles available Range Code: LTR-SLD-COP-POL-BLO	
<b>Style 1</b>	<b>Style 4</b>
Style 2	<b>STYLE 5</b>
Style 3	<b>Style 6</b>
Range Code: LTR-SLD-COP-POL-SER	
<b>Style 7</b>	<b>Style 10</b>
Style 8	<b>STYLE 11</b>
<b>Style 9</b>	<b>Style 12</b>

Depth (mm)	Pik Your Size							
	Height (mm)							
	50	100	150	200	250	300	400	
1.5	15.44	25.17	34.89	44.62	54.35	61.22	77.81	
3	17.22	28.73	40.23	51.74	63.24	71.89	92.05	
5	18.05	30.39	42.72	55.06	67.39	76.87	98.69	
10	22.56	39.40	56.24	73.09	89.93	103.92	134.75	
20		41.98	52.25	62.53	72.80	83.08	109.81	
30		46.26	56.54	66.81	77.09	87.36	112.24	
45		50.13	60.91	71.70	82.48	93.26	114.82	
60		51.29	62.65	74.01	85.37	96.73	124.23	
1.5	15.44	25.17	34.89	44.62	54.35	61.22	77.81	
3	17.22	28.73	40.23	51.74	63.24	71.89	92.05	
5	18.05	30.39	42.72	55.06	67.39	76.87	98.69	
10	23.39	41.06	58.74	76.41	94.08	108.90	141.39	
20		42.99	53.77	64.55	75.33	86.11	114.17	
30		47.28	58.06	68.84	79.62	90.40	116.50	
45		51.29	62.65	74.01	85.37	96.73	124.23	
60		52.30	64.17	76.04	87.90	99.77	124.73	

Manufacturer's recommended prices exclude VAT

Pik Your Options			
Applications		Fixings	
Internal	External	Tape	Stud
✓	✓	✓	✓
✓	✓	✓	✓
✓	✓	✓	✓
✓	✓	-	✓
✓	✓	-	✓
✓	✓	-	✓
✓	✓	-	✓
✓	✓	-	✓
✓	✓	-	✓
✓	✓	-	✓
✓	✓	✓	✓
✓	✓	✓	✓
✓	✓	✓	✓
✓	✓	-	✓
✓	✓	-	✓
✓	✓	-	✓

Note: Pricing is per letter based on the tallest letter in the sentence or word.  
 Above prices are manufacturer's recommended retail prices excluding VAT and include a one year guarantee.  
 For application within 1 mile of coastal areas, a 316 steel upgrade must be applied and could be subject to a surcharge.

Estimated lead time is 3 weeks from order.

**Pricing includes**  
 Fitting Template  
 Choice of fixings  
 Applelec quality inspection

**See your specialist distributor for:**  
 Bespoke options  
 Installation advice  
 Delivery options  
 A full quotation



# Bronze Effect Brushed

The bronze finish gives a feeling of understated heritage.



Finish is lacquered for additional protection.



3D letters have blended edges, ensuring a consistent quality of finish across the whole letter.



Bronze Effect Brushed Metal Finish - Style 1

Pik Your Style	
Styles available Range Code: LTR-SLD-BNZ-BSH-BLO	
<b>Style 1</b>	<b>Style 4</b>
Style 2	<b>STYLE 5</b>
Style 3	<b>Style 6</b>
Range Code: LTR-SLD-BNZ-BSH-SER	
<b>Style 7</b>	<b>Style 10</b>
Style 8	<b>STYLE 11</b>
<b>Style 9</b>	<b>Style 12</b>

Pik Your Size							
Depth (mm)	Height (mm)						
	50	100	150	200	250	300	400
1.5	14.61	23.51	32.40	41.30	50.20	56.23	71.17
3	16.39	27.07	37.74	48.42	59.09	66.91	85.40
5	18.05	30.39	42.72	55.06	67.39	76.87	98.69
10	21.61	37.50	53.40	69.29	85.19	98.22	127.16
20		40.82	50.52	60.21	69.91	79.60	103.08
30		45.11	54.80	64.50	74.19	83.89	103.28
45		49.12	59.39	69.67	79.94	90.22	110.77
60		50.13	60.91	71.70	82.48	93.26	114.82
1.5	14.61	23.51	32.40	41.30	50.20	56.23	71.17
3	16.39	27.07	37.74	48.42	59.09	66.91	85.40
5	18.05	30.39	42.72	55.06	67.39	76.87	98.69
10	22.56	39.40	56.24	73.09	89.93	103.92	134.75
20		41.98	52.25	62.53	72.80	83.08	109.81
30		46.26	56.54	66.81	77.09	87.36	112.24
45		50.13	60.91	71.70	82.48	93.26	114.82
60		51.29	62.65	74.01	85.37	96.73	124.23

Manufacturer's recommended prices exclude VAT

Pik Your Options			
Applications		Fixings	
Internal	External	Tape	Stud
✓	✓	✓	✓
✓	✓	✓	✓
✓	✓	✓	✓
✓	✓	-	✓
✓	✓	-	✓
✓	✓	-	✓
✓	✓	-	✓
✓	✓	-	✓
✓	✓	-	✓
✓	✓	-	✓
✓	✓	-	✓
✓	✓	-	✓

Note: Pricing is per letter based on the tallest letter in the sentence or word. Above prices are manufacturer's recommended retail prices excluding VAT and include a one year guarantee. For application within 1 mile of coastal areas, a 316 steel upgrade must be applied and could be subject to a surcharge.

Estimated lead time is 3 weeks from order.

**Pricing includes**  
 Fitting Template  
 Choice of fixings  
 Applelec quality inspection

**See your specialist distributor for:**  
 Bespoke options  
 Installation advice  
 Delivery options  
 A full quotation



# Polished Stainless Steel



Polished Stainless Steel Metal Finish - Style 1

A beautiful smooth & bright polished stainless steel finish.



Precision laser cut technique produces a consistent finish across the letter.



3D letters have blended edges, ensuring a consistent quality of finish across the whole letter.

Pik Your Style	
Styles available Range Code: LTR-SLD-SLS-POL-BLO	
<b>Style 1</b>	<b>Style 4</b>
Style 2	<b>STYLE 5</b>
Style 3	<b>Style 6</b>
Range Code: LTR-SLD-SLS-POL-SER	
<b>Style 7</b>	<b>Style 10</b>
Style 8	<b>STYLE 11</b>
<b>Style 9</b>	<b>Style 12</b>

Depth (mm)	Pik Your Size							
	Height (mm)							
	50	100	150	200	250	300	400	
1.5	10.10	14.49	18.88	23.27	27.66	29.19	35.11	
3	11.88	18.05	24.22	30.39	36.55	39.87	49.34	
5	12.83	19.95	27.07	34.18	41.30	45.56	56.94	
10	17.22	28.73	40.23	51.74	63.24	71.89	92.05	
20		35.47	42.48	49.50	56.52	63.54	77.58	
30		39.75	46.77	53.79	60.81	67.83	81.86	
45		43.62	51.15	58.67	66.20	73.72	88.77	
60		44.78	52.88	60.99	69.09	77.19	93.40	
1.5	10.10	14.49	18.88	23.27	27.66	29.19	35.11	
3	11.88	18.05	24.22	30.39	36.55	39.87	49.34	
5	12.83	19.95	27.07	34.18	41.30	45.56	56.94	
10	18.05	30.39	42.72	55.06	67.39	76.87	98.69	
20		36.48	44.00	51.53	59.05	66.58	81.63	
30		40.76	48.29	55.81	63.34	70.86	85.91	
45		44.78	52.88	60.99	69.09	77.19	93.40	
60		45.79	54.40	63.01	71.62	80.23	97.45	

Manufacturer's recommended prices exclude VAT

Pik Your Options			
Applications		Fixings	
Internal	External	Tape	Stud
✓	✓	✓	✓
✓	✓	✓	✓
✓	✓	✓	✓
✓	✓	-	✓
✓	✓	-	✓
✓	✓	-	✓
✓	✓	-	✓
✓	✓	-	✓
✓	✓	-	✓
✓	✓	-	✓
✓	✓	✓	✓
✓	✓	✓	✓
✓	✓	✓	✓
✓	✓	-	✓
✓	✓	-	✓
✓	✓	-	✓

Note: Pricing is per letter based on the tallest letter in the sentence or word.  
 Above prices are manufacturer's recommended retail prices excluding VAT and include a one year guarantee.  
 For application within 1 mile of coastal areas, a 316 steel upgrade must be applied and could be subject to a surcharge.

Estimated lead time is 3 weeks from order.

**Pricing includes**  
 Fitting Template  
 Choice of fixings  
 Applelec quality inspection

**See your specialist distributor for:**  
 Bespoke options  
 Installation advice  
 Delivery options  
 A full quotation



# Brushed Stainless Steel

A texturised, brushed stainless steel finish.



Finish is lacquered for additional protection.



3D letters have blended edges, ensuring a consistent quality of finish across the whole letter.



Brushed Stainless Steel Metal Finish - Style 1

Pik Your Style	
Styles available Range Code: LTR-SLD-SLS-BSH-BLO	
<b>Style 1</b>	<b>Style 4</b>
Style 2	<b>STYLE 5</b>
Style 3	<b>Style 6</b>
Range Code: LTR-SLD-SLS-BSH-SER	
<b>Style 7</b>	<b>Style 10</b>
Style 8	<b>STYLE 11</b>
<b>Style 9</b>	<b>Style 12</b>

Pik Your Size							
Depth (mm)	Height (mm)						
	50	100	150	200	250	300	400
1.5	9.27	12.83	16.39	19.95	23.51	24.21	28.47
3	11.05	16.39	21.73	27.07	32.40	34.88	42.70
5	12.83	19.95	27.07	34.18	41.30	45.56	56.94
10	16.39	27.07	37.74	48.42	59.09	66.91	85.40
20		34.45	40.96	47.48	53.99	60.50	73.52
30		38.74	45.25	51.76	58.27	64.79	77.81
45		42.61	49.63	56.65	63.66	70.68	84.72
60		43.62	51.15	58.67	66.20	73.72	88.77
1.5	9.27	12.83	16.39	19.95	23.51	24.21	28.47
3	11.05	16.39	21.73	27.07	32.40	34.88	42.70
5	12.83	19.95	27.07	34.18	41.30	45.56	56.94
10	17.22	28.73	40.23	51.74	63.24	71.89	92.05
20		35.47	42.48	49.50	56.52	63.54	77.58
30		39.75	46.77	53.79	60.81	67.83	81.86
45		43.62	51.15	58.67	66.20	73.72	88.77
60		44.78	52.88	60.99	69.09	77.19	93.40

Pik Your Options			
Applications		Fixings	
Internal	External	Tape	Stud
✓	✓	✓	✓
✓	✓	✓	✓
✓	✓	✓	✓
✓	✓	-	✓
✓	✓	-	✓
✓	✓	-	✓
✓	✓	-	✓
✓	✓	-	✓
✓	✓	-	✓
✓	✓	-	✓
✓	✓	✓	✓
✓	✓	✓	✓
✓	✓	✓	✓
✓	✓	-	✓
✓	✓	-	✓
✓	✓	-	✓

Manufacturer's recommended prices exclude VAT

Note: Pricing is per letter based on the tallest letter in the sentence or word. Above prices are manufacturer's recommended retail prices excluding VAT and include a one year guarantee. For application within 1 mile of coastal areas, a 316 steel upgrade must be applied and could be subject to a surcharge.

Estimated lead time is 3 weeks from order.

**Pricing includes**  
 Fitting Template  
 Choice of fixings  
 Applelec quality inspection

**See your specialist distributor for:**  
 Bespoke options  
 Installation advice  
 Delivery options  
 A full quotation



# Gold Effect Polished



Gold Effect Polished Metal Finish - Style 1



A smooth & bright gold polished finish

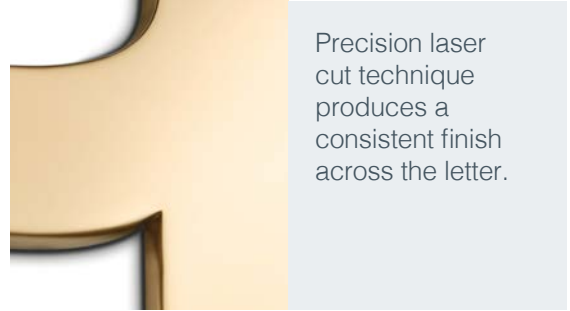

Precision laser cut technique produces a consistent finish across the letter.

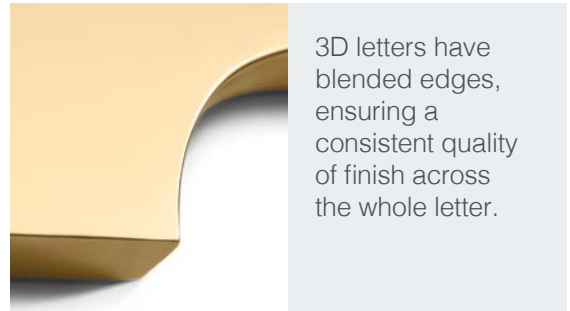

3D letters have blended edges, ensuring a consistent quality of finish across the whole letter.

Metal Finishes

062

Pik Your Style	
Styles available Range Code: LTR-SLD-GLD-POL-BLO	
<b>Style 1</b>	<b>Style 4</b>
Style 2	<b>STYLE 5</b>
Style 3	<b>Style 6</b>
Range Code: LTR-SLD-GLD-POL-SER	
<b>Style 7</b>	<b>Style 10</b>
Style 8	<b>STYLE 11</b>
<b>Style 9</b>	<b>Style 12</b>

Depth (mm)	Pik Your Size							
	Height (mm)							
	50	100	150	200	250	300	400	
1.5	15.44	25.17	34.89	44.62	54.35	61.22	77.81	
3	17.22	28.73	40.23	51.74	63.24	71.89	92.05	
5	18.05	30.39	42.72	55.06	67.39	76.87	98.69	
10	22.56	39.40	56.24	73.09	89.93	103.92	134.75	
20		41.98	52.25	62.53	72.80	83.08	109.81	
30		46.26	56.54	66.81	77.09	87.36	112.24	
45		50.13	60.91	71.70	82.48	93.26	114.82	
60		51.29	62.65	74.01	85.37	96.73	124.23	
1.5	15.44	25.17	34.89	44.62	54.35	61.22	77.81	
3	17.22	28.73	40.23	51.74	63.24	71.89	92.05	
5	18.05	30.39	42.72	55.06	67.39	76.87	98.69	
10	23.39	41.06	58.74	76.41	94.08	108.90	141.39	
20		42.99	53.77	64.55	75.33	86.11	114.17	
30		47.28	58.06	68.84	79.62	90.40	116.50	
45		51.29	62.65	74.01	85.37	96.73	124.23	
60		52.30	64.17	76.04	87.90	99.77	124.73	

Manufacturer's recommended prices exclude VAT

Pik Your Options			
Applications		Fixings	
Internal	External	Tape	Stud
✓	✓	✓	✓
✓	✓	✓	✓
✓	✓	✓	✓
✓	✓	-	✓
✓	✓	-	✓
✓	✓	-	✓
✓	✓	-	✓
✓	✓	-	✓
✓	✓	-	✓
✓	✓	-	✓
✓	✓	-	✓
✓	✓	-	✓
✓	✓	-	✓
✓	✓	-	✓
✓	✓	-	✓

Note: Pricing is per letter based on the tallest letter in the sentence or word. Above prices are manufacturer's recommended retail prices excluding VAT and include a one year guarantee. For application within 1 mile of coastal areas, a 316 steel upgrade must be applied and could be subject to a surcharge.

Estimated lead time is 3 weeks from order.

**Pricing includes**

- Fitting Template
- Choice of fixings
- Applelec quality inspection

**See your specialist distributor for:**

- Bespoke options
- Installation advice
- Delivery options
- A full quotation





# Gold Effect Brushed

A textured brushed gold finish



Finish is lacquered for additional protection.



3D letters have blended edges, ensuring a consistent quality of finish across the whole letter.



Gold Effect Brushed Metal Finish - Style 1

### Pik Your Style

Styles available  
Range Code: LTR-SLD-GLD-BSH-BLO

- Style 1**      **Style 4**
- Style 2**      **Style 5**
- Style 3**      **Style 6**

Range Code: LTR-SLD-GLD-BSH-SER

- Style 7**      **Style 10**
- Style 8**      **Style 11**
- Style 9**      **Style 12**

### Pik Your Size

Depth (mm)	Height (mm)						
	50	100	150	200	250	300	400
1.5	14.61	23.51	32.40	41.30	50.20	56.23	71.17
3	16.39	27.07	37.74	48.42	59.09	66.91	85.40
5	18.05	30.39	42.72	55.06	67.39	76.87	98.69
10	21.61	37.50	53.40	69.29	85.19	98.22	127.16
20		40.82	50.52	60.21	69.91	79.60	103.08
30		45.11	54.80	64.50	74.19	83.89	103.28
45		49.12	59.39	69.67	79.94	90.22	110.77
60		50.13	60.91	71.70	82.48	93.26	114.82
1.5	14.61	23.51	32.40	41.30	50.20	56.23	71.17
3	16.39	27.07	37.74	48.42	59.09	66.91	85.40
5	18.05	30.39	42.72	55.06	67.39	76.87	98.69
10	22.56	39.40	56.24	73.09	89.93	103.92	134.75
20		41.98	52.25	62.53	72.80	83.08	109.81
30		46.26	56.54	66.81	77.09	87.36	112.24
45		50.13	60.91	71.70	82.48	93.26	114.82
60		51.29	62.65	74.01	85.37	96.73	124.23

Manufacturer's recommended prices exclude VAT

### Pik Your Options

Applications		Fixings	
Internal	External	Tape	Stud
✓	✓	✓	✓
✓	✓	✓	✓
✓	✓	✓	✓
✓	✓	-	✓
✓	✓	-	✓
✓	✓	-	✓
✓	✓	-	✓
✓	✓	-	✓
✓	✓	-	✓
✓	✓	-	✓
✓	✓	-	✓
✓	✓	-	✓
✓	✓	-	✓
✓	✓	-	✓
✓	✓	-	✓

Note: Pricing is per letter based on the tallest letter in the sentence or word.  
Above prices are manufacturer's recommended retail prices excluding VAT and include a one year guarantee.  
For application within 1 mile of coastal areas, a 316 steel upgrade must be applied and could be subject to a surcharge.

Estimated lead time is 3 weeks from order.

#### Pricing includes

- Fitting Template
- Choice of fixings
- Applelec quality inspection

#### See your specialist distributor for:

- Bespoke options
- Installation advice
- Delivery options
- A full quotation



---

# Colour Finishes

The versatility of the coloured finishes liberate design restrictions, providing endless opportunities for creativity. The unique grained and brushed detail achieved through the polished, lacquered and painted finish is both distinctive and striking.







# Anodised Purple



Anodised Purple Colour Finish - Style 1



Anodised technique for a decorative finish.



Increased resistance to corrosion & wear.



Exceptional detail.

Pik Your Style	
Styles available Range Code: LTR-SLD-ANO-PPL-BLO	
<b>Style 1</b>	<b>Style 4</b>
Style 2	<b>STYLE 5</b>
Style 3	<b>Style 6</b>
Range Code: LTR-SLD-ANO-PPL-SER	
<b>Style 7</b>	<b>Style 10</b>
Style 8	<b>STYLE 11</b>
<b>Style 9</b>	<b>Style 12</b>

Depth (mm)	Pik Your Size							
	Height (mm)							
	50	100	150	200	250	300	400	
1.5	8.90	17.79	26.69	35.58	44.48	53.38	71.17	
3	10.68	21.35	32.03	42.70	53.38	64.05	85.40	
5	12.34	24.67	37.01	49.34	61.68	74.02	98.69	
10	15.89	31.79	47.68	63.58	79.47	95.37	127.16	

1.5	8.90	17.79	26.69	35.58	44.48	53.38	71.17	
3	10.68	21.35	32.03	42.70	53.38	64.05	85.40	
5	12.34	24.67	37.01	49.34	61.68	74.02	98.69	
10	16.84	33.69	50.53	67.37	84.22	101.06	134.75	

Manufacturer's recommended prices exclude VAT

Pik Your Options			
Applications		Fixings	
Internal	External	Tape	Stud
✓	✓	✓	✓
✓	✓	✓	✓
✓	✓	✓	✓
✓	✓	-	✓

✓	✓	✓	✓
✓	✓	✓	✓
✓	✓	✓	✓
✓	✓	-	✓

Note: Pricing is per letter based on the tallest letter in the sentence or word. Above prices are manufacturer's recommended retail prices excluding VAT and include a one year guarantee.

Estimated lead time is 3 weeks from order.

**Pricing includes**

- Fitting Template
- Choice of fixings
- Applelec quality inspection

**See your specialist distributor for:**

- Bespoke options
- Installation advice
- Delivery options
- A full quotation



# Anodised Green

Anodised technique for a decorative finish.



Increased resistance to corrosion & wear.



Exceptional detail.



Anodised Green Colour Finish - Style 1

Pik Your Style	
Styles available Range Code: LTR-SLD-ANO-GRN-BLO	
<b>Style 1</b>	<b>Style 4</b>
Style 2	<b>STYLE 5</b>
Style 3	<b>Style 6</b>
Range Code: LTR-SLD-ANO-GRN-SER	
<b>Style 7</b>	<b>Style 10</b>
Style 8	<b>STYLE 11</b>
<b>Style 9</b>	<b>Style 12</b>

Pik Your Size							
Depth (mm)	Height (mm)						
	50	100	150	200	250	300	400
1.5	8.90	17.79	26.69	35.58	44.48	53.38	71.17
3	10.68	21.35	32.03	42.70	53.38	64.05	85.40
5	12.34	24.67	37.01	49.34	61.68	74.02	98.69
10	15.89	31.79	47.68	63.58	79.47	95.37	127.16

1.5	8.90	17.79	26.69	35.58	44.48	53.38	71.17
3	10.68	21.35	32.03	42.70	53.38	64.05	85.40
5	12.34	24.67	37.01	49.34	61.68	74.02	98.69
10	16.84	33.69	50.53	67.37	84.22	101.06	134.75

Manufacturer's recommended prices exclude VAT

Pik Your Options			
Applications		Fixings	
Internal	External	Tape	Stud
✓	✓	✓	✓
✓	✓	✓	✓
✓	✓	✓	✓
✓	✓	-	✓

✓	✓	✓	✓
✓	✓	✓	✓
✓	✓	✓	✓
✓	✓	-	✓

Note: Pricing is per letter based on the tallest letter in the sentence or word.  
Above prices are manufacturer's recommended retail prices excluding VAT and include a one year guarantee.

Estimated lead time is 3 weeks from order.

**Pricing includes**

- Fitting Template
- Choice of fixings
- Applelec quality inspection

**See your specialist distributor for:**

- Bespoke options
- Installation advice
- Delivery options
- A full quotation



# Anodised Blue



Anodised Blue Colour Finish - Style 1

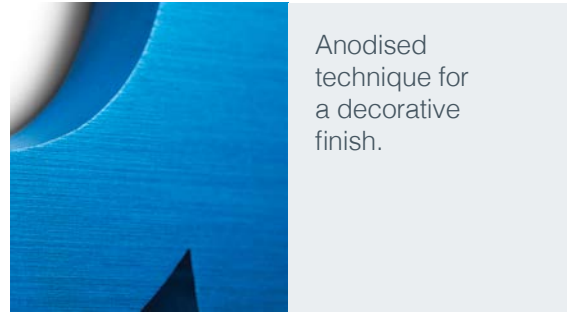

Anodised technique for a decorative finish.

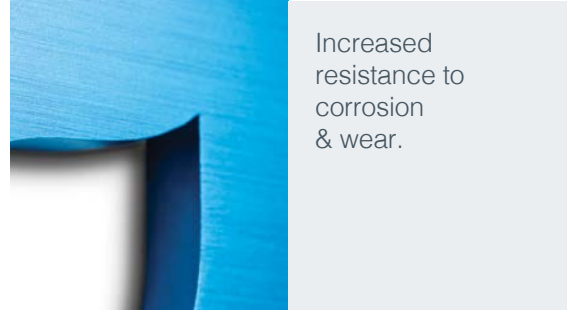

Increased resistance to corrosion & wear.

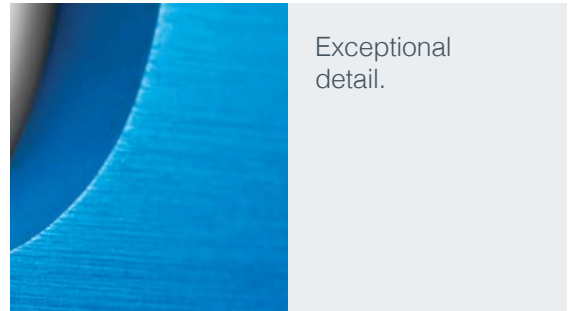

Exceptional detail.

Pik Your Style	
Styles available Range Code: LTR-SLD-ANO-BLU-BLO	
<b>Style 1</b>	<b>Style 4</b>
Style 2	<b>STYLE 5</b>
Style 3	<b>Style 6</b>
Range Code: LTR-SLD-ANO-BLU-SER	
<b>Style 7</b>	<b>Style 10</b>
Style 8	<b>STYLE 11</b>
<b>Style 9</b>	<b>Style 12</b>

Depth (mm)	Pik Your Size							
	Height (mm)							
	50	100	150	200	250	300	400	
1.5	8.90	17.79	26.69	35.58	44.48	53.38	71.17	
3	10.68	21.35	32.03	42.70	53.38	64.05	85.40	
5	12.34	24.67	37.01	49.34	61.68	74.02	98.69	
10	15.89	31.79	47.68	63.58	79.47	95.37	127.16	

1.5	8.90	17.79	26.69	35.58	44.48	53.38	71.17	
3	10.68	21.35	32.03	42.70	53.38	64.05	85.40	
5	12.34	24.67	37.01	49.34	61.68	74.02	98.69	
10	16.84	33.69	50.53	67.37	84.22	101.06	134.75	

Manufacturer's recommended prices exclude VAT

Pik Your Options			
Applications		Fixings	
Internal	External	Tape	Stud
✓	✓	✓	✓
✓	✓	✓	✓
✓	✓	✓	✓
✓	✓	-	✓

✓	✓	✓	✓
✓	✓	✓	✓
✓	✓	✓	✓
✓	✓	-	✓

Note: Pricing is per letter based on the tallest letter in the sentence or word.  
Above prices are manufacturer's recommended retail prices excluding VAT and include a one year guarantee.

Estimated lead time is 3 weeks from order.

**Pricing includes**  
Fitting Template  
Choice of fixings  
Applelec quality inspection

**See your specialist distributor for:**  
Bespoke options  
Installation advice  
Delivery options  
A full quotation



# Anodised Rose

Anodised technique for a decorative finish.



Increased resistance to corrosion & wear.



Exceptional detail.



Anodised Rose Colour Finish - Style 1

Pik Your Style	
Styles available Range Code: LTR-SLD-ANO-RSE-BLO	
<b>Style 1</b>	<b>Style 4</b>
Style 2	<b>STYLE 5</b>
Style 3	<b>Style 6</b>
Range Code: LTR-SLD-ANO-RSE-SER	
<b>Style 7</b>	<b>Style 10</b>
Style 8	<b>STYLE 11</b>
<b>Style 9</b>	<b>Style 12</b>

Depth (mm)	Pik Your Size						
	Height (mm)						
	50	100	150	200	250	300	400
1.5	8.90	17.79	26.69	35.58	44.48	53.38	71.17
3	10.68	21.35	32.03	42.70	53.38	64.05	85.40
5	12.34	24.67	37.01	49.34	61.68	74.02	98.69
10	15.89	31.79	47.68	63.58	79.47	95.37	127.16

1.5	8.90	17.79	26.69	35.58	44.48	53.38	71.17
3	10.68	21.35	32.03	42.70	53.38	64.05	85.40
5	12.34	24.67	37.01	49.34	61.68	74.02	98.69
10	16.84	33.69	50.53	67.37	84.22	101.06	134.75

Manufacturer's recommended prices exclude VAT

Pik Your Options			
Applications		Fixings	
Internal	External	Tape	Stud
✓	✓	✓	✓
✓	✓	✓	✓
✓	✓	✓	✓
✓	✓	-	✓

✓	✓	✓	✓
✓	✓	✓	✓
✓	✓	✓	✓
✓	✓	-	✓

Note: Pricing is per letter based on the tallest letter in the sentence or word.  
Above prices are manufacturer's recommended retail prices excluding VAT and include a one year guarantee.

Estimated lead time is 3 weeks from order.

#### Pricing includes

- Fitting Template
- Choice of fixings
- Applelec quality inspection

#### See your specialist distributor for:

- Bespoke options
- Installation advice
- Delivery options
- A full quotation





# Anodised Black



Anodised Black Colour Finish - Style 1



Anodised technique for a decorative finish.



Increased resistance to corrosion & wear.



Exceptional detail.

070 | Colour Finishes

Pik Your Style	
Styles available Range Code: LTR-SLD-ANO-BLK-BLO	
<b>Style 1</b>	<b>Style 4</b>
Style 2	<b>STYLE 5</b>
Style 3	<b>Style 6</b>
Range Code: LTR-SLD-ANO-BLK-SER	
<b>Style 7</b>	<b>Style 10</b>
Style 8	<b>STYLE 11</b>
<b>Style 9</b>	<b>Style 12</b>

Depth (mm)	Pik Your Size							
	Height (mm)							
	50	100	150	200	250	300	400	
1.5	8.90	17.79	26.69	35.58	44.48	53.38	71.17	
3	10.68	21.35	32.03	42.70	53.38	64.05	85.40	
5	12.34	24.67	37.01	49.34	61.68	74.02	98.69	
10	15.89	31.79	47.68	63.58	79.47	95.37	127.16	

1.5	8.90	17.79	26.69	35.58	44.48	53.38	71.17	
3	10.68	21.35	32.03	42.70	53.38	64.05	85.40	
5	12.34	24.67	37.01	49.34	61.68	74.02	98.69	
10	16.84	33.69	50.53	67.37	84.22	101.06	134.75	

Manufacturer's recommended prices exclude VAT

Pik Your Options			
Applications		Fixings	
Internal	External	Tape	Stud
✓	✓	✓	✓
✓	✓	✓	✓
✓	✓	✓	✓
✓	✓	-	✓

✓	✓	✓	✓
✓	✓	✓	✓
✓	✓	✓	✓
✓	✓	-	✓

Note: Pricing is per letter based on the tallest letter in the sentence or word. Above prices are manufacturer's recommended retail prices excluding VAT and include a one year guarantee.

Estimated lead time is 3 weeks from order.

**Pricing includes**

- Fitting Template
- Choice of fixings
- Applelec quality inspection

**See your specialist distributor for:**

- Bespoke options
- Installation advice
- Delivery options
- A full quotation



# Anodised Gold

Anodised technique for a decorative finish.



Increased resistance to corrosion & wear.



Exceptional detail.



Anodised Gold Colour Finish - Style 1

Pik Your Style	
Styles available Range Code: LTR-SLD-ANO-GLD-BLO	
<b>Style 1</b>	<b>Style 4</b>
Style 2	<b>STYLE 5</b>
Style 3	<b>Style 6</b>
Range Code: LTR-SLD-ANO-GLD-SER	
<b>Style 7</b>	<b>Style 10</b>
Style 8	<b>STYLE 11</b>
<b>Style 9</b>	<b>Style 12</b>

Pik Your Size							
Depth (mm)	Height (mm)						
	50	100	150	200	250	300	400
1.5	8.90	17.79	26.69	35.58	44.48	53.38	71.17
3	10.68	21.35	32.03	42.70	53.38	64.05	85.40
5	12.34	24.67	37.01	49.34	61.68	74.02	98.69
10	15.89	31.79	47.68	63.58	79.47	95.37	127.16
1.5	8.90	17.79	26.69	35.58	44.48	53.38	71.17
3	10.68	21.35	32.03	42.70	53.38	64.05	85.40
5	12.34	24.67	37.01	49.34	61.68	74.02	98.69
10	16.84	33.69	50.53	67.37	84.22	101.06	134.75

Manufacturer's recommended prices exclude VAT

Pik Your Options			
Applications		Fixings	
Internal	External	Tape	Stud
✓	✓	✓	✓
✓	✓	✓	✓
✓	✓	✓	✓
✓	✓	-	✓
✓	✓	✓	✓
✓	✓	✓	✓
✓	✓	-	✓

Note: Pricing is per letter based on the tallest letter in the sentence or word. Above prices are manufacturer's recommended retail prices excluding VAT and include a one year guarantee.

Estimated lead time is 3 weeks from order.

#### Pricing includes

- Fitting Template
- Choice of fixings
- Applelec quality inspection

#### See your specialist distributor for:

- Bespoke options
- Installation advice
- Delivery options
- A full quotation



# Anodised Silver



Anodised Silver Colour Finish - Style 1



Anodised technique for a decorative finish.



Increased resistance to corrosion & wear.

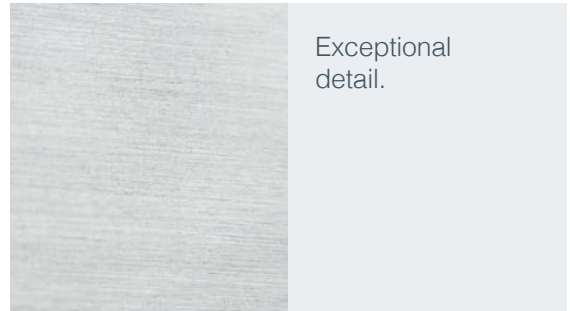

Exceptional detail.

Pik Your Style	
Styles available Range Code: LTR-SLD-ANO-SLV-BLO	
<b>Style 1</b>	<b>Style 4</b>
Style 2	<b>STYLE 5</b>
Style 3	<b>Style 6</b>
Range Code: LTR-SLD-ANO-SLV-SER	
<b>Style 7</b>	<b>Style 10</b>
Style 8	<b>STYLE 11</b>
<b>Style 9</b>	<b>Style 12</b>

Depth (mm)	Pik Your Size							
	Height (mm)							
	50	100	150	200	250	300	400	
1.5	8.90	17.79	26.69	35.58	44.48	53.38	71.17	
3	10.68	21.35	32.03	42.70	53.38	64.05	85.40	
5	12.34	24.67	37.01	49.34	61.68	74.02	98.69	
10	15.89	31.79	47.68	63.58	79.47	95.37	127.16	
1.5	8.90	17.79	26.69	35.58	44.48	53.38	71.17	
3	10.68	21.35	32.03	42.70	53.38	64.05	85.40	
5	12.34	24.67	37.01	49.34	61.68	74.02	98.69	
10	16.84	33.69	50.53	67.37	84.22	101.06	134.75	

Manufacturer's recommended prices exclude VAT

Pik Your Options			
Applications		Fixings	
Internal	External	Tape	Stud
✓	✓	✓	✓
✓	✓	✓	✓
✓	✓	✓	✓
✓	✓	-	✓
✓	✓	✓	✓
✓	✓	✓	✓
✓	✓	-	✓

Note: Pricing is per letter based on the tallest letter in the sentence or word.  
Above prices are manufacturer's recommended retail prices excluding VAT and include a one year guarantee.

Estimated lead time is 3 weeks from order.

**Pricing includes**  
Fitting Template  
Choice of fixings  
Applelec quality inspection

**See your specialist distributor for:**  
Bespoke options  
Installation advice  
Delivery options  
A full quotation



# Anodised Bronze

Anodised technique for a decorative finish.



Increased resistance to corrosion & wear.



Exceptional detail.



Anodised Bronze Colour Finish - Style 1

Pik Your Style	
Styles available Range Code: LTR-SLD-ANO-BNZ-BLO	
<b>Style 1</b>	<b>Style 4</b>
Style 2	<b>STYLE 5</b>
Style 3	<b>Style 6</b>
Range Code: LTR-SLD-ANO-BNZ-SER	
<b>Style 7</b>	<b>Style 10</b>
Style 8	<b>STYLE 11</b>
<b>Style 9</b>	<b>Style 12</b>

Pik Your Size							
Depth (mm)	Height (mm)						
	50	100	150	200	250	300	400
1.5	8.90	17.79	26.69	35.58	44.48	53.38	71.17
3	10.68	21.35	32.03	42.70	53.38	64.05	85.40
5	12.34	24.67	37.01	49.34	61.68	74.02	98.69
10	15.89	31.79	47.68	63.58	79.47	95.37	127.16
1.5	8.90	17.79	26.69	35.58	44.48	53.38	71.17
3	10.68	21.35	32.03	42.70	53.38	64.05	85.40
5	12.34	24.67	37.01	49.34	61.68	74.02	98.69
10	16.84	33.69	50.53	67.37	84.22	101.06	134.75

Manufacturer's recommended prices exclude VAT

Pik Your Options			
Applications		Fixings	
Internal	External	Tape	Stud
✓	✓	✓	✓
✓	✓	✓	✓
✓	✓	✓	✓
✓	✓	-	✓
✓	✓	✓	✓
✓	✓	✓	✓
✓	✓	-	✓

Note: Pricing is per letter based on the tallest letter in the sentence or word.  
Above prices are manufacturer's recommended retail prices excluding VAT and include a one year guarantee.

Estimated lead time is 3 weeks from order.

**Pricing includes**  
Fitting Template  
Choice of fixings  
Applelec quality inspection

**See your specialist distributor for:**  
Bespoke options  
Installation advice  
Delivery options  
A full quotation



Obsidian Colour Finish - Style 1

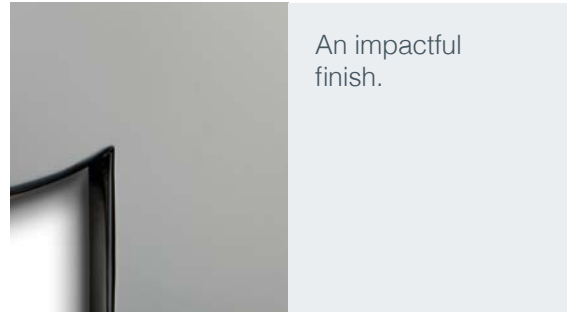

An impactful finish.



Precision lasering produces a consistent finish.

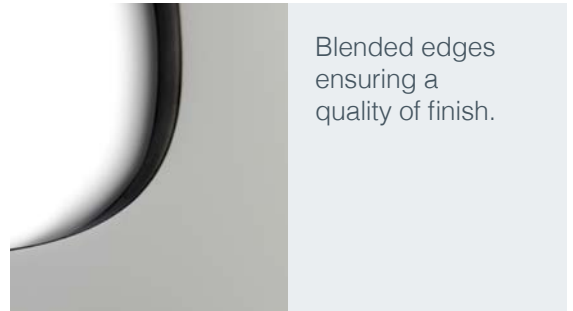

Blended edges ensuring a quality of finish.

Pik Your Style	
Styles available Range Code: LTR-SLD-OBS-POL-BLO	
<b>Style 1</b>	<b>Style 4</b>
Style 2	<b>STYLE 5</b>
Style 3	<b>Style 6</b>
Range Code: LTR-SLD-OBS-POL-SER	
<b>Style 7</b>	<b>Style 10</b>
Style 8	<b>STYLE 11</b>
<b>Style 9</b>	<b>Style 12</b>

Depth (mm)	Pik Your Size							
	Height (mm)							
	50	100	150	200	250	300	400	
1.5	15.44	25.17	34.89	44.62	54.35	61.22	77.81	
3	17.22	28.73	40.23	51.74	63.24	71.89	92.05	
5	18.05	30.39	42.72	55.06	67.39	76.87	98.69	
10	22.56	39.40	56.24	73.09	89.93	103.92	134.75	
20		41.98	52.25	62.53	72.80	83.08	109.81	
30		46.26	56.54	66.81	77.09	87.36	112.24	
45		50.13	60.91	71.70	82.48	93.26	114.82	
60		51.29	62.65	74.01	85.37	96.73	124.23	
1.5	15.44	25.17	34.89	44.62	54.35	61.22	77.81	
3	17.22	28.73	40.23	51.74	63.24	71.89	92.05	
5	18.05	30.39	42.72	55.06	67.39	76.87	98.69	
10	23.39	41.06	58.74	76.41	94.08	108.90	141.39	
20		42.99	53.77	64.55	75.33	86.11	114.17	
30		47.28	58.06	68.84	79.62	90.40	116.50	
45		51.29	62.65	74.01	85.37	96.73	124.23	
60		52.30	64.17	76.04	87.90	99.77	124.73	

Manufacturer's recommended prices exclude VAT

Pik Your Options			
Applications		Fixings	
Internal	External	Tape	Stud
✓	✓	✓	✓
✓	✓	✓	✓
✓	✓	✓	✓
✓	✓	-	✓
✓	✓	-	✓
✓	✓	-	✓
✓	✓	-	✓
✓	✓	-	✓
✓	✓	-	✓
✓	✓	-	✓
✓	✓	-	✓
✓	✓	-	✓
✓	✓	-	✓

Note: Pricing is per letter based on the tallest letter in the sentence or word.  
Above prices are manufacturer's recommended retail prices excluding VAT and include a one year guarantee.

Estimated lead time is 3 weeks from order.

**Pricing includes**  
Fitting Template  
Choice of fixings  
Applelec quality inspection

**See your specialist distributor for:**  
Bespoke options  
Installation advice  
Delivery options  
A full quotation



Powder-coated stainless steel produces a high quality finish.

Available in a choice of RAL colours. Please refer to page 76.

Highly resistant to corrosion.

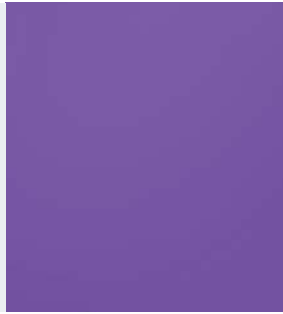

Painted Colour Finish - Style 1

Pik Your Style		Pik Your Size							Pik Your Options				
Styles available Range Code: LTR-SLD-ALU-PNT-BLO		Height (mm)							Applications		Fixings		
		Depth (mm)	50	100	150	200	250	300	400	Internal	External	Tape	Stud
<b>Style 1</b>	<b>Style 4</b>	1.5	4.99	7.12	10.68	14.23	17.79	21.35	28.47	✓	✓	✓	✓
		3	5.34	10.68	16.01	21.35	26.69	32.03	42.70	✓	✓	✓	✓
		5	7.12	14.23	21.35	28.47	35.58	42.70	56.94	✓	✓	✓	✓
<b>Style 2</b>	<b>STYLE 5</b>	10	10.68	21.35	32.03	42.70	53.38	64.05	85.40	✓	✓	-	✓
		20		21.78	32.67	43.56	54.66	65.77	87.55	✓	✓	-	✓
		30		22.21	33.31	44.42	55.95	67.48	89.69	✓	✓	-	✓
<b>Style 3</b>	<b>Style 6</b>	45		23.01	34.52	46.02	57.53	69.03	92.05	✓	✓	-	✓
		60		24.67	37.01	49.34	61.68	74.02	98.69	✓	✓	-	✓
Range Code: LTR-SLD-ALU-PNT-SER		1.5	4.99	7.12	10.68	14.23	17.79	21.35	28.47	✓	✓	✓	✓
<b>Style 7</b>	<b>Style 10</b>	3	5.34	10.68	16.01	21.35	26.69	32.03	42.70	✓	✓	✓	✓
		5	7.12	14.23	21.35	28.47	35.58	42.70	56.94	✓	✓	✓	✓
<b>Style 8</b>	<b>STYLE 11</b>	10	11.51	23.01	34.52	46.02	57.53	69.03	92.05	✓	✓	-	✓
		20		23.44	35.16	46.88	58.81	70.75	94.19	✓	✓	-	✓
		30		23.87	35.80	47.74	60.10	72.46	96.33	✓	✓	-	✓
<b>Style 9</b>	<b>Style 12</b>	45		24.67	37.01	49.34	61.68	74.02	98.69	✓	✓	-	✓
		60		26.57	39.85	53.14	66.42	79.71	106.28	✓	✓	-	✓

Manufacturer's recommended prices exclude VAT

Note: Pricing is per letter based on the tallest letter in the sentence or word. Above prices are manufacturer's recommended retail prices excluding VAT and include a one year guarantee.

Estimated lead time is 3 weeks from order.

**Pricing includes**

- Fitting Template
- Choice of fixings
- Applelec quality inspection

**See your specialist distributor for:**

- Bespoke options
- Installation advice
- Delivery options
- A full quotation



Your specific choice of painted finishes can be colour matched by selecting the following RAL codes.

															
Green beige 1000	Beige 1001	Sand yellow 1002	Signal yellow 1003	Golden yellow 1004	Honey yellow 1005	Maize yellow 1006	Daffodil yellow 1007	Brown beige 1011	Lemon yellow 1012	Oyster white 1013	Ivory 1014	Light ivory 1015	Sulfur yellow 1016	Saffron yellow 1017	Zinc yellow 1018
															
Grey beige 1019	Olive yellow 1020	Rape yellow 1021	Traffic yellow 1023	Ochre yellow 1024	Luminous yellow 1026	Curry 1027	Melon yellow 1028	Broom yellow 1032	Dahlia yellow 1033	Pastel yellow 1034	Pearl-beige Metallic 1035	Pearl gold Metallic 1036	Sun yellow 1037	Yellow orange 2000	Red orange 2001
															
Vermilion 2002	Pastel orange 2003	Pure orange 2004	Luminous orange 2005	Luminous bright orange 2007	Bright red 2008	Traffic orange 2009	Signal orange 2010	Deep orange 2011	Salmon orange 2012	Pearl orange Metallic 2013	Flame red 3000	Signal red 3001	Carmine red 3002	Ruby red 3003	Purple red 3004
															
Wine red 3005	Black red 3007	Oxide red 3009	Brown red 3011	Beige red 3012	Tomato red 3013	Antique pink 3014	Light pink 3015	Coral red 3016	Rose 3017	Strawberry red 3018	Traffic red 3020	Salmon red 3022	Luminous red 3024	Luminous bright red 3026	Raspberry red 3027
															
Pure red 3028	Orient red 3031	Pearl ruby red Metallic 3032	Pearl pink Metallic 3033	Red lilac 4001	Red violet 4002	Heather violet 4003	Claret violet 4004	Blue lilac 4005	Traffic purple 4006	Purple violet 4007	Signal violet 4008	Pastel violet 4009	Telemagenta 4010	Pearl violet Metallic 4011	Pearl blackberry Metallic 4012
															
Violet blue 5000	Green blue 5001	Ultramarine blue 5002	Sapphire blue 5003	Black blue 5004	Signal blue 5005	Brilliant blue 5007	Grey blue 5008	Azure blue 5009	Gentian blue 5010	Steel blue 5011	Light blue 5012	Cobalt blue 5013	Pigeon blue 5014	Sky blue 5015	Traffic blue 5017
															
Turquoise blue 5018	Capri blue 5019	Ocean blue 5020	Water blue 5021	Night blue 5022	Distant blue 5023	Pastel blue 5024	Pearl gentian blue Metallic 5025	Pearl night blue Metallic 5026	Patina green 6000	Emerald green 6001	Leaf green 6002	Olive green 6003	Blue green 6004	Moss green 6005	Grey olive 6006
															
Bottle green 6007	Brown green 6008	Fir green 6009	Grass green 6010	Reseda green 6011	Black green 6012	Reed green 6013	Yellow olive 6014	Black Olive 6015	Turquoise green 6016	May green 6017	Yellow green 6018	Pastel green 6019	Chrome green 6020	Pale green 6021	Olive grab 6022
															
Traffic green 6024	Fern green 6025	Opal green 6026	Light green 6027	Pine green 6028	Mint green 6029	Signal green 6032	Mint turquoise 6033	Pastel turquoise 6034	Pearl green Metallic 6035	Pearl opal green Metallic 6036	Pure green 6037	Luminous green 6038	Squirrel grey 7000	Silver grey 7001	Olive grey 7002
															
Moss grey 7003	Signal grey 7004	Mouse grey 7005	Beige grey 7006	Khaki grey 7008	Green grey 7009	Tarpaulin grey 7010	Iron grey 7011	Basalt grey 7012	Brown grey 7013	Slate grey 7015	Anthracite grey 7016	Black grey 7021	Umbrage grey 7022	Concrete grey 7023	Graphite grey 7024
															
Granite grey 7026	Stone grey 7030	Blue grey 7031	Pebble grey 7032	Cement grey 7033	Yellow grey 7034	Light grey 7035	Platinum grey 7036	Dusty grey 7037	Agate grey 7038	Quartz grey 7039	Window grey 7040	Traffic grey A 7042	Traffic grey B 7043	Silk grey 7044	Tele-grey 1 7045
															
Tele-grey 2 7046	Tele-grey 4 7047	Pearl mouse grey Metallic 7048	Green brown 8000	Ochre brown 8001	Signal brown 8002	Clay brown 8003	Copper brown 8004	Fawn brown 8007	Olive brown 8008	Nut brown 8011	Red brown 8012	Sepia brown 8014	Chestnut brown 8015	Mahogany brown 8016	Chocolate brown 8017
															
Grey brown 8019	Black brown 8022	Orange brown 8023	Beige brown 8024	Pale brown 8025	Terra brown 8028	Pearl copper Metallic 8029	Cream 9001	Grey white 9002	Signal white 9003	Signal black 9004	Jet black 9005	White aluminium Metallic 9006	Grey aluminium Metallic 9007	Pure white 9010	Graphite black 9011
															
Traffic white 9016	Traffic black 9017	Papyrus white 9018	Pearl light grey Metallic 9022	Pearl dark grey Metallic 9023											



# Styles Available

## Block

Style 1      **abcdefghijklmnopqrstuvwxy**  
**ABCDEFGHIJKLMN****OPQRSTUVWXYZ**

Style 2      abcdefghijklmnopqrstuvwxy  
 ABCDEFGHIJKLMN**OPQRSTUVWXYZ**

Style 3      abcdefghijklmnopqrstuvwxy  
 ABCDEFGHIJKLMN**OPQRSTUVWXYZ**

Style 4      **abcdefghijklmnopqrstuvwxy**  
**ABCDEFGHIJKLMN****OPQRSTUVWXYZ**

Style 5      **ABCDEFGHIJKLMN****OPQRSTUVWXYZ**  
Only available in uppercase

Style 6      abcdefghijklmnopqrstuvwxy  
 ABCDEFGHIJKLMN**OPQRSTUVWXYZ**

## Serif

Style 7      **abcdefghijklmnopqrstuvwxy**  
**ABCDEFGHIJKLMN****OPQRSTUVWXYZ**

Style 8      abcdefghijklmnopqrstuvwxy  
 ABCDEFGHIJKLMN**OPQRSTUVWXYZ**

Style 9      **abcdefghijklmnopqrstuvwxy**  
**ABCDEFGHIJKLMN****OPQRSTUVWXYZ**

Style 10      abcdefghijklmnopqrstuvwxy  
 ABCDEFGHIJKLMN**OPQRSTUVWXYZ**

Style 11      ABCDEFGHIJKLMN**OPQRSTUVWXYZ**  
 ABCDEFGHIJKLMN**OPQRSTUVWXYZ**

Style 12      **abcdefghijklmnopqrstuvwxy**  
**ABCDEFGHIJKLMN****OPQRSTUVWXYZ**

## Neon

Style 13      abcdefghijklmnopqrstuvwxy  
 ABCDEFGHIJKLMN**OPQRSTUVWXYZ**

Style 14      abcdefghijklmnopqrstuvwxy  
 ABCDEFGHIJKLMN**OPQRSTUVWXYZ**



# Fixings, Application in coastal areas & Colour temperatures

Available fixing options are specific to the product and are specified on the individual pages.

Flush fitting example: Tape

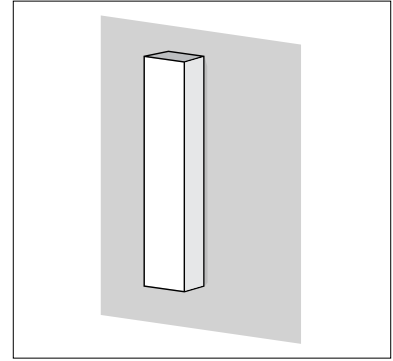
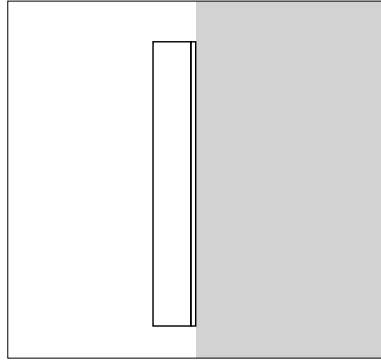
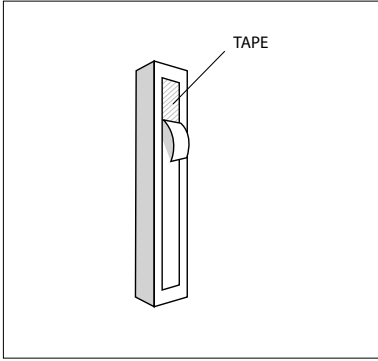

Flush fitting example: Stud

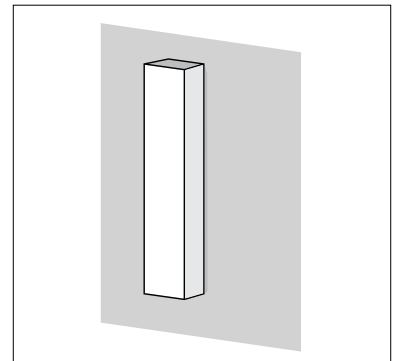
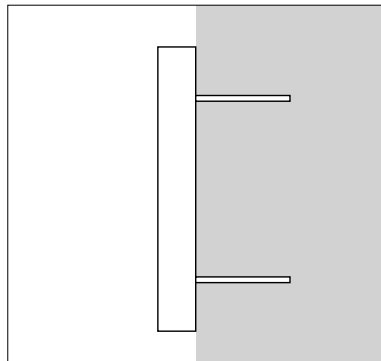
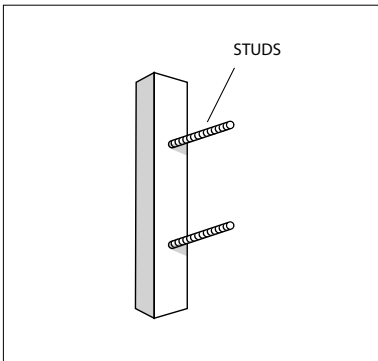

Offset fitting example: Stud with spacer

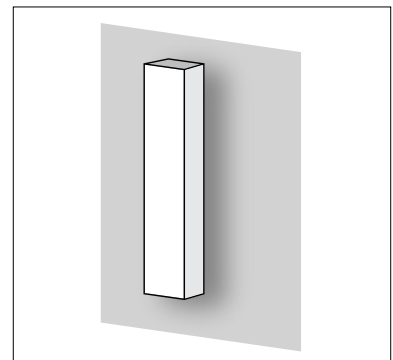
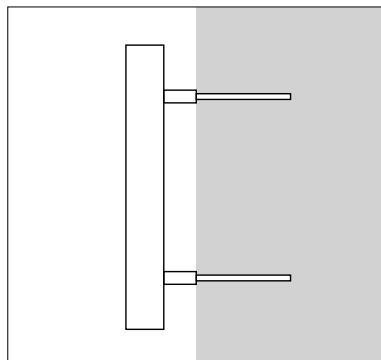
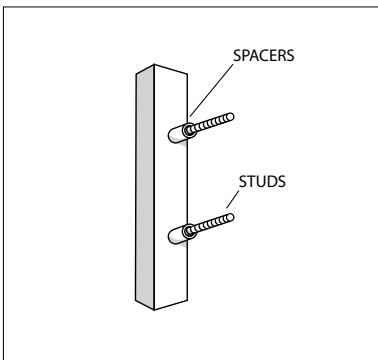

Please note: spacers are not supplied but can be used to offset the lettering from the mounting surface.

## Application in coastal areas

Applelec SignPik products are not suitable for external use within 1 mile of the coast. For application within 1 mile of coastal areas, a 316 steel upgrade must be applied and could be subject to a surcharge. Contact your Applelec SignPik partner to discuss.

## Colour temperatures

Illuminated and neon products are available in two colour temperatures – 3000K warm white and 5000K cool white.

Where an illuminated product is ordered with a painted finish, the light colour can be specified to match the RAL colour.





# Bespoke signage solutions

Applelec have over 20 years of experience manufacturing bespoke signage solutions. We have and always will only supply to specialist, approved partners.

## Want to make an alteration to an Applelec SignPik product...?

If your signage requirements are a little different to the Applelec SignPik range, you can ask your preferred partner to provide a quotation and timescale for bespoke alternatives, such as different sizes or fonts.

## Need a completely custom made signage solution...?

For any signage solution, even completely unique and bespoke designs, our experienced team will work with your preferred partner to deliver your signage requirements with excellence.

Our comprehensive range of signage solutions includes fabricated signage, plaques and plates, sign trays, totems and monoliths.





Contact your specialist distributor for:

Bespoke options  
Installation advice  
Delivery options  
A full quotation

Go to [www.applelec.co.uk/signpik](http://www.applelec.co.uk/signpik)  
to find your specialist distributor.